



Hurricane preparedness of Navy family housing.

| | |
|---------------|---|
| Title | Hurricane preparedness of Navy family housing. |
| Item Type | Thesis |
| Authors | George, Thomas F. |
| URI | https://hdl.handle.net/10945/8482 |
| Publisher | University of Florida |
| Date Issued | 1996 |
| Download date | 2026-06-29 02:08:54 |
| Link to Item | https://hdl.handle.net/10945/8482 |

Downloaded from NPS Archive: Calhoun



DUDLEY KNOX LIBRARY
NAVAL POSTGRADUATE SCHOOL
MONTEREY CA 93943-5101

HURRICANE PREPAREDNESS
OF NAVY FAMILY HOUSING

BY

THOMAS F. GEORGE

//

A REPORT PRESENTED TO THE GRADUATE COMMITTEE
OF THE DEPARTMENT OF CIVIL ENGINEERING IN
PARTIAL FULFILLMENT OF THE REQUIREMENTS
FOR THE DEGREE OF MASTER OF ENGINEERING

UNIVERSITY OF FLORIDA

Summer 1996

11650
Ga 1638
C.1

TABLE OF CONTENTS

| | |
|--|----|
| Chapter I - Introduction | 1 |
| Hurricane Overview | 1 |
| Navy Housing Overview | 2 |
| Chapter II - Review of Recent Major Hurricanes | 3 |
| Overview | 3 |
| Hurricane Camille | 3 |
| Hurricane Hugo | 6 |
| Hurricane Andrew | 9 |
| Hurricanes Erin and Opal | 13 |
| Chapter III - Common Prevalent Damage of Recent U.S. Hurricanes | 18 |
| Overview | 18 |
| Typical Building Structural Systems | 18 |
| One to Two Story Light Wood-Frame Buildings | 19 |
| Roof Framing Systems | 20 |
| Masonry Wall Buildings | 20 |
| Combination Masonry First Floor with Light Wood-Frame Second Floor Buildings | 20 |
| Wood-Frame Modular Buildings | 21 |
| Accessory Structures | 21 |
| Roof Cladding Systems | 21 |
| Exterior Wall Openings | 22 |

| | |
|--|----|
| Flood Related Damage | 23 |
| Chapter IV - Recommended Actions for Hurricane Damage Prevention | 25 |
| Overview | 25 |
| Roof Cladding and Roof Framing System | 25 |
| Exterior Wall Openings | 29 |
| Light Wood-Frame Buildings | 35 |
| Masonry Buildings | 35 |
| Modular Buildings | 41 |
| Accessory Structures | 41 |
| Chapter V - Summary of SBCCI Standard for Hurricane Resistant Residential Construction, SSTD 10-93 | 42 |
| Overview | 42 |
| Chapter 1 - General Requirements | 42 |
| Chapter 2 - Buildings with Masonry Exterior Walls | 43 |
| Chapter 3 - Buildings with Wood-Framed Exterior Walls | 46 |
| Chapter 4 - Combined Masonry and Wood Exterior Construction | 49 |
| Chapter VI - Existing Hurricane Preparedness of Three Naval Installations | 54 |
| Overview | 54 |
| Naval Station Mayport | 55 |
| Naval Air Station Jacksonville | 57 |
| Naval Submarine Support Base Kings Bay, Georgia | 59 |
| Chapter VII - Life Cycle Cost Analysis of Naval Installations | 61 |
| Overview | 61 |

| | |
|---|-----------|
| Net Present Value Calculations | 71 |
| Cost Savings of Corrective Actions | 73 |
| Chapter VIII - Recommendations and Conclusions | 74 |
| Overview | 74 |
| Specific Recommendations for Studied Naval Installations | 74 |
| Naval Station Mayport | 74 |
| Naval Air Station Jacksonville | 76 |
| Naval Submarine Support Base Kings Bay, Georgia | 77 |
| General Recommendations for Navy Housing Construction and Renovations | 78 |
| Design | 78 |
| Construction | 79 |
| Planning and Maintenance | 80 |
| Conclusions | 80 |
| Bibliography | 82 |

CHAPTER I INTRODUCTION

Hurricane Overview

One of the greatest threats to the maintenance and up-keep of our countries naval installations is that of hurricanes. Each year throughout the summer and autumn months, coastlines are prey to nature's fury in the form of these storms which originate and build their strength in the ocean only to unleash their incredible power on the facilities and living creatures which inhabit the waterfront, and in some cases, much further inland. The devastation caused by past major hurricanes has been catastrophic, resulting in billions of dollars in lost property as well as human life. Each time that a major hurricane occurs, communities are forced to rebuild their homes, businesses, schools, churches, and all of the other facilities that are taken for granted by most people. On each of these occasions, the effected residents and local Governments rebuild in accordance with building codes that may not have been in effect when the damaged or destroyed structures were originally built. In many cases, the damage incurred during the storm could have been avoided if the buildings in question had been retrofitted with equipment specifically designed to enable buildings to withstand hurricanes.

Although one might initially think that it would be wise to retrofit any coastal structure with hurricane protection, in some instances, it is not practical to do so. Depending upon the circumstances, a private citizen may not be able to afford costly retrofitting costs or may feel that hurricane insurance is more cost-effective. Each citizen, business, or local Government must consider a number of factors when determining if protective measures should be implemented. These factors include the value and condition of the present structure, life expectancy, retrofit costs, insurance coverage, the cost of an entirely new facility, and the associated costs of temporary lodging, temporary business operations, or temporary business shutdown.

Navy Housing Overview

In the case of the Navy bases, most of which are located in coastal areas, the Navy incurs all of the costs of damage and the related expenses associated with temporary relocations and shutdowns. Since Navy bases provide housing facilities for many military families, a highly destructive hurricane would leave many servicepersons and their families homeless or living under unsatisfactory conditions for an extended period of time. These conditions drastically reduce an installation's readiness and ability to perform its intended mission as well as the missions of the numerous Navy ships, aircraft squadrons, and other tenant commands which call a particular installation home. Of course, any Navy base which incurs severe damage to housing facilities will obviously suffer more severe destruction to other higher value structures. These circumstances cannot be ignored and would not be overcome easily, but if the individual serviceperson's home and family life remain fairly well intact, that serviceperson will be more effective in his or her duties in getting the base back on its feet.

CHAPTER II REVIEW OF RECENT MAJOR HURRICANES

Overview

This report will study the need, practicality, and feasibility of retrofitting Navy housing facilities to provide greater protection against hurricanes. In order to make a thorough study of this topic, it is necessary to study recent hurricanes and their effects on coastal housing facilities of various structural types. The hurricanes that will be discussed include the following: Hurricane Camille which struck the Mississippi and Louisiana Gulf Coast in 1969 and remains the most powerful storm to strike United States soil; Hurricane Hugo which caused extensive damage in the Caribbean and the Carolina coastline in 1989; Hurricane Andrew which nearly destroyed Homestead Air Force Base in 1992 and was the most costly hurricane in U.S. history in terms of monetary damage caused in south Florida and Louisiana; and Hurricanes Erin and Opal which both struck the Pensacola area in Florida's panhandle during the highly active hurricane season of 1995.

Hurricane Camille

In terms of intensity and relative cost of damage at the time, Hurricane Camille was probably the most catastrophic hurricane in U. S. history. The storm has had a lasting effect on the gulf coast of Mississippi and Louisiana where there are still constant reminders of Camille's impact. Camille is the only hurricane to hit the U.S. mainland as a Category V storm, though another storm struck the Florida Keys around Labor Day 1935, before the storms received names, with even greater intensity than Camille. Hurricanes are categorized according to the Saffir-Simpson Hurricane Scale as follows:

Saffir - Simpson Hurricane Scale

| <u>Category</u> | <u>Winds (mph)</u> | <u>Storm Surge (feet)</u> | <u>Damage Characteristics</u> |
|-----------------|--------------------|---------------------------|-------------------------------|
| I | 74-95 | 4-5 | Minimal |
| II | 96-110 | 6-8 | Moderate |
| III | 111-130 | 9-12 | Extensive |
| IV | 131-154 | 13-18 | Extreme |
| V | >155 | 18 | Catastrophic |

Camille reached tropical storm status on the morning of Thursday, August 14, 1969 when it was located slightly less than 500 miles south of Miami. It grew in intensity quickly and was categorized as a hurricane the next morning. As Camille moved toward the southwest coast of Cuba that afternoon, it was evident that it would be a major hurricane, with maximum winds of 115 mph extending out 125 to 150 miles to the north of the center and 50 miles to the south. After racking the western portion of Cuba on Friday evening, Camille headed for the Gulf of Mexico where it was expected to intensify.

With the hurricane located 420 miles south of Panama City, Florida on early Saturday morning, a hurricane watch was ordered for the Gulf coast from Biloxi, Mississippi to St. Marks, Florida. At the time Camille was traveling north-northwest at approximately 10 mph and was expected to continue on a northerly path. As weather forecasters followed the storm throughout that day, the watch was upgraded to a warning, calling Camille a "very intense and dangerous storm." By Sunday morning, Camille had shifted to the west, now posing the greatest threat to the coastlines of Louisiana, Mississippi, and Alabama. At 3 o'clock that afternoon, Camille's eye, unusually compact and dangerous, was located 120 miles southeast of New Orleans, with winds estimated at nearly 200 mph near the center of the storm. The outer edges of the hurricane were expected to move inland at Gulfport, Mississippi by early Sunday night.

By 7 o'clock that evening, the eye of Camille was 60 miles south of Gulfport, and ~~her~~ western quadrants were raking southeastern Louisiana. Estimated wind velocities of 140 to 160 mph were reported at Garden Island Bay and Pillottown, while tide levels were measured at up to 16 feet above sea level. At 9 o'clock, the storm was 35 miles south of Gulfport. The eye of the storm, once again much smaller and more intense than most hurricanes, went inland just east of Gulfport at Waveland and Bay St. Louis. Much of the weather measuring equipment in Mississippi was destroyed, but some individuals who braved the storm estimated the winds at 160 mph. A reliable high-water of 22.6 feet was found, but other less reliable marks measured over 24 feet.

Camille lost its intensity quickly after hitting land, reaching tropical depression status before crossing the northern border of Mississippi. However, Camille brought heavy rains to Tennessee, Kentucky, and the southern portion of West Virginia over the next two days as it headed east toward Virginia and the Atlantic Ocean. The storm appeared to have spent all of its strength when it suddenly intensified on Tuesday night, bringing torrential rains, flooding, and mudslides to southeastern West Virginia and Virginia. Within 8 hours on Wednesday the 20th, Camille dumped 27 inches of rain on central Virginia. Camille finally reached the Atlantic Ocean and merged with a frontal system on Friday the 22nd. The storm's disastrous course had finally been run.

The tremendous intensity of Hurricane Camille left tragic scars on the areas which it pounded. The death toll for Hurricane Camille was 262, including 137 in the coastal areas of Mississippi and 114 in the flooded areas of Virginia. The damages left in Camille's wake were estimated at \$1,420,700,000 with over half of those losses occurring in Mississippi.

Southern Mississippi residents remain extremely wary of hurricanes and their destructive nature. More than twenty years after the fury of Camille, residents of the coastal cities of Gulfport and Biloxi, are tremendously cautious when a storm begins to

build in the Atlantic. Having also experienced Hurricane Frederic in 1979, which struck somewhat further west than Camille, Mississippi residents stress and methodically practice hurricane preparedness. The local Navy Seabee base in Gulfport and Keesler Air Force Base in Biloxi hold mandatory training for their servicepersons at the onset of each hurricane season.

Beyond the death and destruction caused by Camille, which serve as ominous reminders for the ferocity of a catastrophic Category V hurricane, the rapid nature in which it developed its tremendous intensity as well as the unpredictable path it traveled should provide proof of the need for personal preparedness and discipline to heed storm warnings.

Hurricane Hugo

Hurricane Hugo was the second most destructive hurricane in U. S. history with approximately \$10 billion in damage. A Category IV hurricane, it also was the eleventh most intense hurricane to strike American soil. Hugo began as a tropical disturbance off the west African coast on September 9, 1989. The storm gained intensity as it crossed the Atlantic and reached hurricane status by September 13. On Friday, September 15 at 9 PM, the National Weather Service office in San Juan, Puerto Rico issued a hurricane watch. It was elevated to a hurricane warning at 3:15 PM on the 16th. Prior to striking Puerto Rico, Hugo bore down on several Caribbean islands including Guadeloupe and Montserrat, and the U. S. Virgin Islands of St. Croix and St. Thomas. Before landfall, Hugo reached a maximum sustained wind speed of 190 mph, making it a Category V storm at the time. By the time it struck the islands on the 17th, Hugo had reduced in intensity to a Category IV hurricane. On Guadeloupe, approximately half of the capital city of Pointe-a-Pitre was destroyed, and Montserrat also experienced severe damage. St. Thomas and St. Croix were also hard hit with St. Croix taking the brunt of Hugo's intense

winds for an unusually long period of time on the night of the 17th and the early morning of Monday the 18th. Hugo then proceeded through Vieques sound and over Puerto Rico at about 8:30 AM on the 18th. The majority of Puerto Rico's damage occurred in San Juan, which is not surprising since it is by far the largest city of the small island territory. The coastal residents of Puerto Rico were fortunate to be alerted early enough by the island's Civil Defense Disaster Interagency Committee to evacuate their homes.

By the time Hugo had passed over Puerto Rico, it weakened to a Category II storm on the Saffir-Simpson scale. A hurricane watch was issued for the Atlantic coast from St. Augustine, Florida to Cape Hatteras, North Carolina on Monday the 18th of September. On the morning of the 19th, a hurricane warning was issued for roughly the range of coastline. As the storm continued to move northwest to the U.S. mainland, it once again gained strength over the open ocean. Forecasters predicted that Hugo would strike mainland soil with Category III intensity. Wisely, the governor of South Carolina ordered the evacuation of barrier islands, beaches, and peninsulas on the 19th because the storm eventually built up to a Category IV hurricane. Luckily, Charleston officials also ordered the evacuation of that city on the 19th.

Hurricane Hugo made landfall just before midnight on Thursday, September 21, very near Charleston. Hugo's peak wind gust was recorded as 137 mph just before landfall at the North Charleston Navy Yard. After landfall, the maximum measured sustained surface wind was 87 mph, yet it was estimated to have reached 121 mph. Three hours after landfall, in the areas of Columbia and Sumter, South Carolina, Hugo's wind speed was below hurricane force, and three more hours later, 200 miles inland at Charlotte, North Carolina, winds were measured at 54 mph.

Damages in the Caribbean approached \$3 billion with St. Croix, St. Thomas, and the northeastern corner of Puerto Rico suffering the worst. The cities of San Juan, Fajardo, and Luquillo in Puerto Rico were hit very hard, with Luquillo receiving the most

severe damage. Damage to buildings ranged from superficial to total devastation. As to be expected, roof damage was most prevalent, and nonstructural elements such as doors and windows suffered extensive damage. Single story concrete buildings withstood the storm fairly well, with minimal damage.

The affected islands' infrastructure suffered greatly with electrical distribution lines being the most hard hit. This precipitated other problems, particularly efforts to pump water out of flooded areas and structures, and transmitting public service broadcasts via television and radio. Telephone communications were also affected as a result of downed poles, oftentimes the same poles which hampered the electrical system. In the Virgin Islands, some areas were without telephone service for nearly six months. Finally, a number of storm related mishaps severely limited the water supply in the storm damaged islands.

In North Carolina and South Carolina, the cost of storm related damages was estimated at \$7 billion. As expected, coastal structures received the heaviest damage. Wind damage was observed along a wide path along the coast and at least 200 miles inland to Charlotte. Well-built structures along the coastline sustained very little damage, but foundation failures due to wind were common where structures were elevated on unreinforced masonry piers. Major structural damage was incurred in areas where the strongest winds occurred. These damages included the loss of roof structure, collapse of single-story masonry buildings, complete destruction of mobile homes, and extensive damage to wood-framed construction and pre-engineered metal buildings. Falling trees caused the most damage in the inland areas.

The most severely hampered public lifeline resulting from Hugo in the Carolinas was the loss of electrical power. Between 1 million and 1.5 million citizens were without power from 2 to 3 weeks. Of course, the loss of power also severely hampered other important services such as transportation, communication, water, and wastewater

facilities. Some roadways were washed out on the barrier islands and one bridge to the islands experienced failure, but storm debris in roadways and the destruction of traffic signs and signals were more prevalent on the mainland. Airport operations were also impacted, particularly at Charleston where the airport was closed to commercial traffic for a week. Telephone systems performed well as a result of more than 80 percent of the telephone lines being underground. Power outages did affect radio and television service at both the transmitting and receiving ends, and the lack of electricity also made somewhat of an impact on water and wastewater systems. On the barrier islands, severe beach erosion destroyed water and sewer lines and exposed septic tanks.

It is estimated that between 4000 and 5000 historic buildings in South Carolina were damaged by Hugo. These damages were a result of both the strong winds and storm surge, plus the rains which followed the Hugo's passage. The combination of wind damaged roofs and the rainwater caused severe water damage to these older structures. Many chimneys and architectural details were lost, and subtle damage also surfaced in the form of shear cracks in masonry walls, as well as mechanical damage and fungal damage to plaster.

Loss of life in the Caribbean totaled 29, including 22 on Puerto Rico. Most of the deaths were the result of drownings or electrocutions. In the Carolinas, the death toll reached 27 with seven wind-related deaths and six water/boating fatalities. The other 14 deaths occurred after the storm and were primarily from cleanup accidents and open flames being used for light.

Hurricane Andrew

Hurricane Andrew in 1992 was the costliest hurricane in U.S. history, causing an estimated \$25 billion in damage in the southern Florida peninsula and south-central Louisiana. In fact, the amount of devastation left in Andrew's wake makes it the most

expensive natural disaster of any kind ever in our country. Hurricane Andrew was the strongest Category IV storm ever to hit the United States. Only Hurricane Camille and the hurricane which struck the Florida Keys in 1935, both Category V storms, were of greater intensity. Andrew's cost was so great because of the tremendous population and property values in south Florida. Hurricane Camille does not nearly approach Andrew's cost because of the smaller population of the affected area as well as 23 years between the two storms and the effect of inflation on the U.S. dollar during that time.

As its name indicates, Andrew was the first tropical storm of the 1992 season, occurring fairly late in the season. It reached hurricane strength on the morning of August 22, 1992 and approached Category V intensity just 36 hours later. Andrew was a Category IV storm when its eye passed over northern Eleuthera Island in the Bahamas late on the 23rd, registering a storm surge of 23 feet in one location. It passed over the southern islands of the Bahamas very early on the 24th. After weakening during its pass over the Bahamas, the hurricane rapidly intensified over the next few hours as it headed for the south Florida coastline.

Andrew struck the Florida coastline in southern Dade County in the early morning hours of August 24. The maximum sustained wind speed during landfall over Florida was estimated at 145 mph. The highest measurement of storm surge on the Florida coastline was 16.9 feet, but it was considerably less in most affected Florida areas, typically in the 4-7 feet range. Andrew moved nearly due westward over Florida and crossed the southern peninsula in about four hours, falling to Category III status yet remaining a very strong hurricane when its eye passed over the Florida southwestern coast and headed into the Gulf of Mexico. Upon reaching the Gulf, weather conditions caused Andrew to shift to the northwest, moving at a speed of approximately 8 knots. Still a Category III hurricane, Andrew struck a sparsely populated area of the south-central Louisiana coast, approximately 20 miles west-southwest of Morgan City, in the early morning hours of the

26th. Andrew weakened quickly after landfall, dropping to tropical storm strength in about 10 hours and tropical depression strength in just 12 more hours. By the 28th of August, Andrew began to merge with a frontal system over the mid-Atlantic states.

The damages as a result of Hurricane Andrew are staggering. As stated previously, the total damage estimate was approximately \$25 billion with nearly \$23 billion occurring in southern Florida. Andrew destroyed more than 25,000 homes in southern Florida and damaged 100,000 more. Damage to boats in the Dade County area totaled \$500 million. In Louisiana, damage was estimated at \$1 billion, and losses in the Gulf of Mexico to oil industry equipment were estimated to be \$500 million. The Bahamas suffered nearly \$250 million in damage. Despite these tremendous losses, the results could have been much more devastating. Andrew was a very tight and compact storm so the width of its path was fairly small, especially compared to Hurricane Hugo. Had Andrew been a few miles wider or struck the Florida coastline a few miles to the north, the cities of Miami, Miami Beach, Fort Lauderdale and other highly populated communities would have been devastated, and the damage totals would have been substantially higher than they already were.

The types of damage incurred as a result of Hurricane Andrew in the south Florida area varied and included the following lifeline related elements: utility centers and generation plants, above-ground utilities, and transportation facilities. There was relatively little damage to lifeline facilities such as power plants, water and wastewater plants, and hospitals. Electrical distribution lines and telephone lines performed poorly during Andrew, as they did in Hurricane Hugo, but outages were not as widespread or as lengthy as in Hugo. Many traffic signals malfunctioned as far north as Fort Lauderdale, and many traffic signs were lost. As a result of these breakdowns in the transportation systems, National Guardsmen, state, and local employees were called upon to direct traffic

for a period of a few days. Had this not been required, those personnel could have utilized in more productive recovery efforts.

Damages to conventional residential structures were extensive, mainly due to the failure of roofing materials, doors, and windows. Homes that were built prior to the up-to-date codes sustained much heavier damage. These failures resulted in wind and rain penetration of the structures which caused major interior damage. Damages were even more extensive when roof sheathing and gable ends collapsed. Overall, the structures which were constructed according to code requirements performed well.

The loss of roofing materials was the most important and costly aspect of the residential damage. In addition to the weather penetration which resulted from roofing losses, the loose shingles and tiles acted as flying debris and had significant effects on neighboring structures.

As with the loss of roof shingles and tiles, damage to windows and doors allowed for wind and rain penetration in many homes. The resulting interior damage included collapsed ceilings and interior non-load bearing walls, and it was so great in many cases that the homes were deemed uninhabitable.

Roof-sheathing losses and gable end failures were widespread and related to each other in some cases. The loss of roof sheathing was normally caused by inadequate nailing. These poor construction practices included nails being too far apart and nails which missed the truss or rafter beneath the sheathing. A large number of the sheathing failures occurred near the ridge of gable roofs or along the eaves, where high winds were likely to have made the greatest impact. Other gable-end failures were determined to be the result of an inadequate attachment and support of the gable-end roof truss to the top of the end wall.

Connections in lateral load paths of structures fared fairly well against Hurricane Andrew. In some cases, exterior wall failure occurred when there was no plywood

backing against hardboard siding. On the whole, careful attention was paid to uplift, but lack of strength and continuity in the lateral load path was noted in several buildings which incurred substantial structural damage.

The number of deaths attributed directly to Hurricane Andrew was 26. Fifteen deaths occurred in Florida, 8 in Louisiana, and 3 in the Bahamas. An additional 39 deaths were indirectly attributed to Hurricane Andrew with most of those happening in Florida.

Hurricanes Erin and Opal

Pensacola, Florida and its surrounding area was the most recent geographic location to suffer the effects of a major hurricane. In fact, the area was impacted by two hurricanes between early August and early October of 1995. The first hurricane to strike the western end of the Florida panhandle was Erin, a Category I storm which struck land on the morning of August 3.

Erin was a storm which began as an area of disturbed weather over the Bahamas on July 30. It developed into a tropical storm the following day, and became a Category I hurricane by early August 1. Erin struck the Atlantic coast of Florida near Vero Beach in the very early morning hours of August 2. As Erin crossed the Florida peninsula, it weakened back to a tropical storm, and then regained Category I strength in the Gulf of Mexico. Moving west-northwest path, Erin made landfall at Pensacola Beach shortly before noon on August 3, packing maximum winds of approximately 90 mph. Erin again weakened quickly, falling all the way to a tropical depression less than a day after sweeping over Pensacola.

As a Category I storm, Hurricane Erin caused much less damage than the other hurricanes previously discussed. The wind speeds were relatively low in comparison, but wind damage was indeed significant. Erin carried a very small storm surge, which had little effect on the Pensacola area. However, just two months later, Pensacola and other

nearby communities would suffer tremendous damage as a result of storm surge from the more powerful Hurricane Opal.

In contrast to Hurricane Erin, Opal originated from a tropical wave off the west coast of Africa, just as most of the more powerful hurricanes. After twelve days of movement, the wave merged with a low pressure area near the western Caribbean Sea on September 23. This combined system moved west-northwest toward the Yucatan peninsula over the next few days with little storm development. On the 27th, a tropical depression began to form approximately 70 nautical miles south-southeast of Cozumel, Mexico. The storm moved slowly westward over the Yucatan peninsula over the next three days, strengthening into a tropical storm by the time it crossed over the northern coast of the Yucatan and into the Bay of Campeche (southwest of the Gulf of Mexico) on the 30th.

By midday on October 2, Opal had acquired hurricane strength and began to turn to the north. Throughout the next two days, the storm strengthened even further, accelerated, and turned toward the northeast. By the early morning hours of October 4, Opal reached Category IV strength with maximum sustained winds estimated at 145 mph. The hurricane weakened slightly before landfall at Pensacola Beach, making it a Category III storm by the time it struck at approximately 5 PM local time. After racking the Pensacola area, Opal weakened very rapidly, becoming a tropical storm over southern Alabama and a tropical depression over southeastern Tennessee.

There are conflicting reports as to Opal's maximum sustained wind speed in the Pensacola area, but most sources are certain that they exceeded 100 mph. The winds actually appeared to have less of an effect than those of Hurricane Erin, which was a smaller storm, though Opal's winds were distributed over a wider area. Investigators had a difficult time determining if damage had been caused by Opal or was yet unrepaired from

Erin. It is safe to say that Erin caused damage that likely would have been incurred as a result of Opal, had Erin never occurred.

Water from the storm surge was the most significant cause of damage by Hurricane Opal. The water damage was unusually out of proportion to the wind damage. It is possible that the large ocean movement was set in motion while Opal was at its peak strength in the Gulf of Mexico, before weakening as it approached land. The maximum storm surge was difficult to ascertain, but it was estimated to have reached 15 feet.

Rains associated with Hurricane Opal were very heavy. The Florida panhandle, as well as parts of Alabama and Georgia, experienced rainfall ranging from 5 to 10 inches. States as far north as Maryland also experienced rains as a result of Opal. These rains were in fact beneficial because of the prolonged dry period in the eastern U.S. just prior to the storm.

As stated before, most of the heavy damage caused by Hurricane Opal was the result of the heavy storm surge. Beach and sand dune erosion was heavy from Pensacola Beach to Panama City. U.S. Highway 98 was completely breached east of Fort Walton Beach, and that area also had severe sand dune erosion. In some places, the sand appeared to have been deposited almost as if it were drifting snow. In fact, in one case at Fort Walton Beach, a swimming pool was almost completely filled with sand.

The storm surge caused structural failures of buildings in beach areas, most of which was attributed to erosion of soil from around and under building foundations. Properly elevated buildings withstood the storm surge fairly well except in cases where piles were inadequately imbedded. Buildings that were improperly elevated incurred substantial damage to wood stud or masonry bearing walls, sometimes resulting in complete destruction of the buildings. Newer homes, for the most part, performed well against the storm surge, largely because better attention had been given to elevating the structures.

The building envelope (weather integrity of roof coverings, structural integrity of doors and windows, structural integrity of roof and wall cladding, etc.) of most homes was the most serious problem caused by Opal's winds. Wind damage was apparently less than that caused by Hurricane Erin except in the most eastern areas affected by the storm. As discussed earlier, it will remain unclear how much damage was caused by Opal's winds because of the small amount of time between the two hurricanes.

The performance of wind coverings during both Erin and Opal ranged from good to poor. Roof cladding was not as severe a problem in Opal as it had been in Erin, likely because most repairs had been made after Erin, and the decking was much better prepared than before. Regarding exterior wall cladding, damage to vinyl siding systems appeared to be the most significant. This damage was usually due to the tearing of the siding over nail heads, although in some cases the siding was cut by flying debris. Damage to brick veneer occurred in some instances where it was noted the veneer ties were not embedded into the mortar joints in the veneer. With no anchoring of the brick veneer to the wall, the veneer could not resist wind loads.

Damage to doors and windows was incurred as a result of Hurricane Opal, but these problems were not that widespread. When they did occur, the damages were significant. In some cases, window failures on the windward side of a building would result in damage or collapse of a leeward wall because of the internal pressure. In other instances, failures of gable end walls, which are especially susceptible to hurricane force winds, were the result of window failures in other walls. In some cases the failures of these windows precipitated the failure of poorly constructed walls themselves. For example, cases were noted in which only one dowel was used to tie vertical wall steel to footing.

Garage doors incurred little damage as a result of Opal's winds, but some near the waterfront reflected minor damage to lower panels, indicating damage caused by storm surge.

Damage estimates of Hurricanes Erin and Opal are difficult to ascertain due to the short time between the storms. Though destructive, these hurricanes did not come close to approaching the level of damage attributed to Camille, Hugo, and Andrew. They do provide more valuable information that can be utilized to make homes and other buildings better prepared for future hurricanes.

CHAPTER III

COMMON PREVALENT DAMAGE OF RECENT U.S. HURRICANES

Overview

There are many common types of damage that were incurred during the major hurricanes that were discussed in the first chapter. This chapter will explore the damage in detail and describe suggested actions to prevent this type of damage in future storms. The damages that will be discussed will focus on one to two story dwelling units of wood-frame or masonry construction since these are the most common among military housing structures. The hurricane which provided the majority of information in this chapter was Andrew, which is predictable since it caused such a large amount of damage. In fact in 1993, shortly after Hurricane Andrew struck south Florida, the Southern Building Code Congress International altered its Standard For Hurricane Resistant Residential Construction SSTD 10-93 in an effort to implement new engineering design standards to withstand heavy winds and possible storm surge. Since this standard did not apply to most of the homes affected by Hurricanes Erin and Opal, it is difficult at this time to ascertain the complete effectiveness of the new standards, but in a few cases, the standards did apply.

Typical Building Structural Systems

Primary structural systems support the building against all lateral and vertical loads. In residential structures, these systems include the exterior loadbearing walls, non-loadbearing wall panels, roof structure and diaphragm, and foundation. The strength of the structure depends upon these items as well as the connections between them. In the structural systems, the all important connections form a "load transfer path." A proper load transfer path is the most critical element in preventing catastrophic damage from high

winds. The roofing system of a residential structure is also critical. Failure of the roof diaphragm or trusses results in the failure of the building envelope, and in addition to the likely wind damage that is incurred, the interior of the home is left highly susceptible to heavy rains which are normally associated with a hurricane.

One- to Two Story Light Wood-Frame Buildings

Catastrophic failure of one-to two story light wood-frame buildings occurs more frequently than catastrophic failures of residential structures of any other type. Total building failure is normally the result of negative pressure and/or induced internal pressure overloading the building envelope. Improper installation as well as the absence of framing connections, load transfer straps, or bracing from between walls and roof components are the most prevalent causes of these building failures.

The wood-frame gable ends of roof structures are the most common locations for failures in these types of buildings. Gable ends require bracing from within the roof structure for lateral force resistance. The gable sections are an essential part of the integrity of the overall structural system during a storm with heavy winds. In particular, when properly braced, gable ends act as a stiffener for the roof diaphragm with the primary stiffening coming from the roof sheathing (typically plywood). In a hurricane, if the roof sheathing separates from the roof trusses and the gable ends are not braced, severe structural damage is almost certain to occur.

Other deficiencies to structural members that are typically found after heavy storms include improper sill-to masonry and sill to concrete foundation connections, unbraced stud columns, inadequate connections between exterior and interior shear walls, and faulty spliced wall top-plate systems. These deficiencies alone or in combination with others compromise the structural integrity of entire wall and roof systems.

Roof Framing Systems

As stated before, roof framing systems are typically designed and built with light wood trusses and plywood sheathing. Most of the trusses are prefabricated and perform well under hurricane wind forces, but the connection of the sheathing to the trusses is sometimes inadequate. In most cases, the cause of this deficiency is substandard workmanship by either stapling or improper nailing. In addition, a trend in design and construction of the past has been to overlook adequate truss bridging, system-wide lateral bracing, cross-bracing at end trusses, as well as gable end stiffening. These practices leave a system with total reliance on sheathing for truss-roof bracing, thus inviting disastrous effects.

Masonry Wall Buildings

The most prevalent cause of failure of masonry buildings is a lack of vertical wall reinforcing. Not surprisingly, concrete block and stucco building systems usually perform better than all-wood-frame construction, but failures do indeed still occur. Conditions which typically lead to masonry building failure include the following: poor mortar joints between wall and slab pours; lack of tie-beams, horizontal reinforcing, tie columns, and tie-anchors; and misplaced or missing hurricane straps between walls and the roof structure.

Combination Masonry First Floor with Light Wood-Frame Second Floor Buildings

Failure of wood-frame second floor systems normally occurs in a similar manner to all-wood-frame residences. Structural breakdowns at wood-frame gable ends, poor connections of wood sill plates to first story masonry walls, inadequate anchoring of sole plates to masonry are some of the most common causes of structural failures. A shortage

of bolted anchors, unsecured anchors, and even substituting items such as cut nails for anchors are some of the possible roots of structural failure between the two stories.

Wood-Frame Modular Buildings

Modular buildings typically perform fairly well in hurricanes. The module-to-module combination of units provides an inherently rigid system which performs much better than conventional residential framing. Performance is typically better in both the transverse and longitudinal directions, however most failures which do occur impact the end wall units. This is normally attributed to poor connections of the tops of the walls to the roof diaphragms. Loss of roof sheathing to some degree can be expected either due to building envelope breach or external wind forces and debris. Rafters usually remain intact due to the system's strong rigidity as a result of short spans and strong connections.

Accessory Structures

Accessory structures such as porch enclosures, carport systems, sheds, and playground equipment normally do not hold up well in strong hurricanes. These items are not a major concern themselves, but there is danger in the potential of them becoming flying debris. By code, these items are designed for only 75 mph wind speeds.

Roof Cladding Systems

Roof cladding is comprised of both underlayment material (e.g. building felt) and the topmost covering (e.g. tiles and shingles) which are sequentially installed. Roof cladding damage is probably the most likely type of damage that any residential structure will incur. Buildings which escape major structural damage in a Category IV hurricane are almost certain to receive some roof cladding damage from wind and/or flying debris.

Damage to roof cladding systems normally results in interior damage from wind-driven rains entering the building.

Considerable losses are sometimes observed in composition shingles systems. Substandard workmanship is a considerable contributing factor. This poor work includes torn shingles and insufficiently attached shingles (i.e. insufficient number of staples or incorrectly located or oriented staples). In extreme hurricanes of Category IV or greater, tears or pullouts from proper staple connections are a possibility.

In tile shingle systems, failures occur as a result of both nailing and/or mortar connections which are critical to the attachment of precast and molded tile systems. Failures of underlayment, lack of bond between the underlayment and mortar, and lack of bond between the mortar and tile are also common causes of damage to these cladding systems. Generally, flat-shaped tiles perform better in heavy winds, and clay tiles are more susceptible to shattering from the impact of flying debris. However, the clay tiles provide better adhesion to mortar than the concrete tiles. In almost all roofing systems, no matter how well built a system is designed and constructed, it is still likely to incur some damage as a result of flying debris from nearby poorly built systems.

Exterior Wall Openings

The breaching of the building envelope by failure of openings such as doors and windows normally results in significant interior damage and sometimes structural damage due to internal air pressure. Generally, window protection such as plywood and shutters perform well, but flying debris can result in window protection failure. Most residents do not protect or reinforce doors that do not include glazing as part of their make-up, but failure of solid doors certainly can occur. In addition, structures with adequate roof ventilation tend to withstand building envelope penetration by the wind because this ventilation provides relief for the built-up pressure in the building.

Failure of garage doors is a major contributing cause of building envelope penetration. Garage doors fail when the heavy winds cause door deflection greater than the amount allowed in the design. This excessive deflection results in deformation of the entire garage door assembly which will ultimately lead to separation of the door from the opening. Depending upon the floor plan of the house, this can allow a tremendous buildup of internal pressure in the home and lead to major interior and structural damage. It is interesting to note that single car garage doors appear to withstand heavy winds much better than two-car garage doors, likely because of the shorter span.

Regarding entry doors, french doors as well as double doors made from wood and metal also fail on occasion during hurricanes. Most of the failures pertain to the doors' center pins. In metal doors, the deflection of the doors results in the pulling out of the center pins. Most wood doors seem to withstand deflection, but shattering of the door leafs at the location of the center pin leads to failure.

Window systems, particularly large ones such as sliding glass doors, are highly susceptible to high wind pressures and flying debris. Normally, glazing failures occur so readily that window frames are not impacted. Storm shutters and plywood boarding are invaluable in preventing window penetration and protecting the overall integrity of the building envelope.

Flood Related Damage

Homes along shore fronts should always expect some degree of water damage as a result of a severe hurricane. During Hurricane Opal, it was reported that over 3000 structures were destroyed by the storm surge. Damage to homes should be expected to vary depending upon the home's distance from the shoreline and the type of foundation. Elevated structures built to new building codes perform well. Older structures near the

beach or with slab on grade construction normally do not fare well, though some masonry buildings manage to hold up.

For the most part, elevated homes built on properly embedded piles can be expected to withstand a very strong storm surge. Scouring sometimes has an effect on elevated piles by moving the sand in which the piles are deeply (usually 10 feet or more) embedded. Casting a concrete slab at grade between the piles protects the sand below and limits the effect of scouring.

Channeling and shielding are countering effects which are the result of a heavy storm surge. In some cases, attached residential buildings serve as shields to buildings further inland. On the other hand, some arrangements of similar residential structures cause the storm surge to become concentrated or channeled with higher velocity and greater height. Channeling normally has a great effect on the end units of structures such as townhomes. With the increased velocity and height, there is much greater water pressure at the corners of the structures, sometimes causing dramatic damage to the end units while the remainder of the building remains well intact. Channeling and shielding are very unpredictable effects and somewhat infrequent. It is nearly impossible to consider these effects in the design stage, but effective shielding using properly maintained sand dunes can drastically reduce the likelihood of these conditions occurring.

CHAPTER IV RECOMMENDED ACTIONS FOR HURRICANE DAMAGE PREVENTION

Overview

In order to make recommendations to the Navy for the specific bases that were studied as well as general recommendations for all bases, a thorough review of recommendations made by experts in this field of study was necessary. The following recommendations are made based upon findings of damage assessments following the recent hurricanes discussed in Chapter I. Most of the recommendations are based upon the Federal Emergency Management Agency's report entitled Building Performance: Hurricane Andrew in Florida.

Roof Cladding and Roof Framing Systems

1. Inspect roof bracing and sheathing prior to installation of roof underlayment.
2. Install diagonal braces for top chord of roof trusses at gable ends as well as ridge braces and horizontal braces along the building length (see Figures IV-A & IV-B).
3. Install additional roof bracing for gable roof overhang (see Figure IV-C).
4. Install composition shingles which are manufactured and rated as satisfactory for high wind areas. In absence of the satisfactory shingles, use a hot-mopped underlayment or other water-resistant membrane to provide protection from water infiltration (see Figure IV-D).
5. Minimum nailing requirements and enforcement thereof for roof sheathing should be strictly enforced. A sheathing inspection should take place prior to the installation of the roof covering.
5. Quality control of roof tile installation should be enforced by ensuring consistent mortar pad placement and installation. In addition, prefabricated eave closure strips should be used to elevate the butt end of the first, or eave, tile to attain the proper slope.

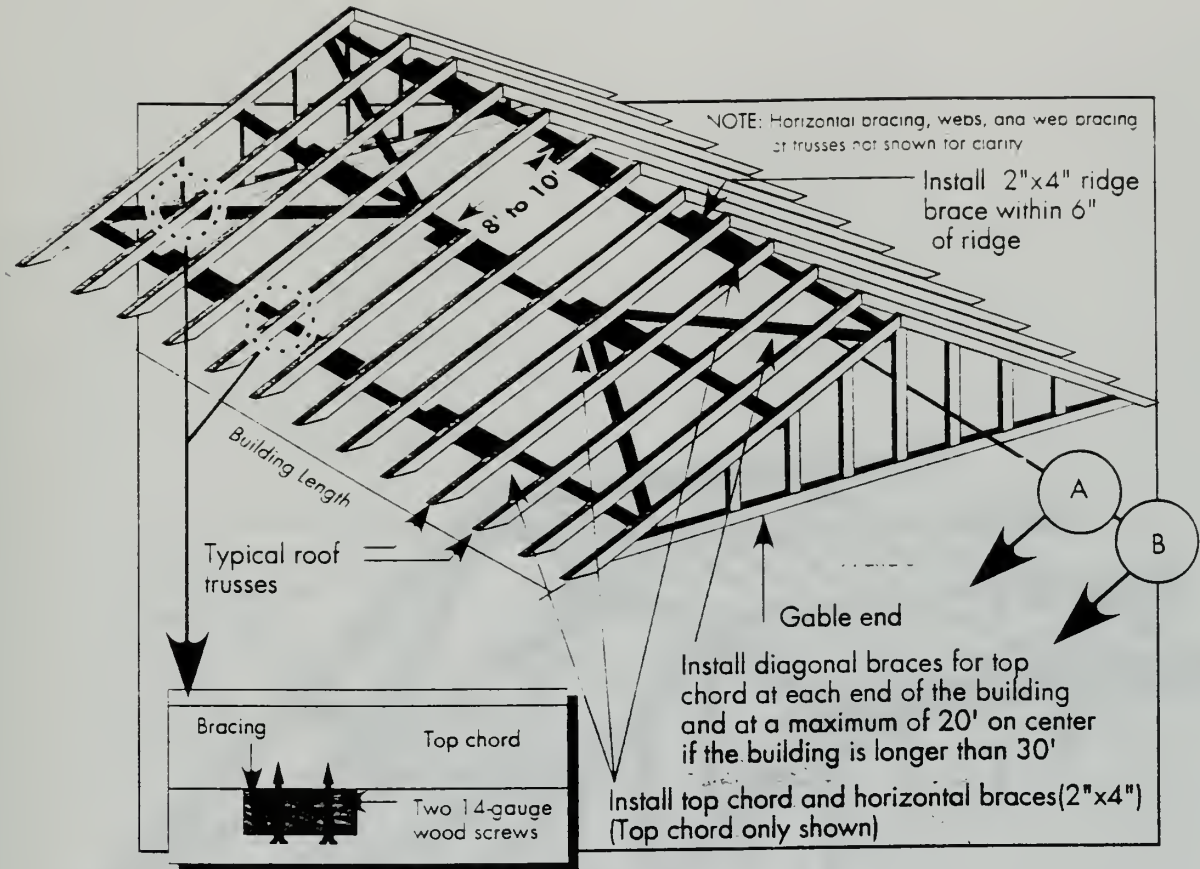

FIGURE IV-A
TYPICAL ROOF TRUSS TOP CHORD

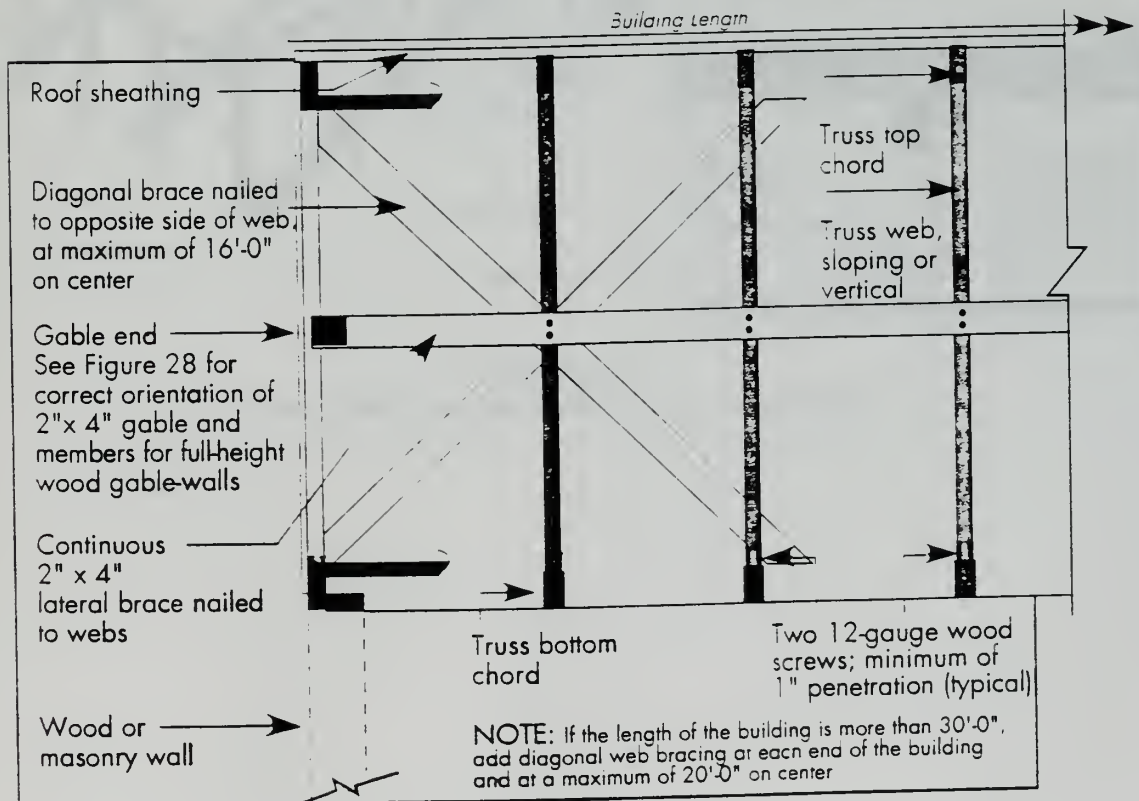

FIGURE IV-B
TYPICAL TRUSS DIAGONAL BRACING

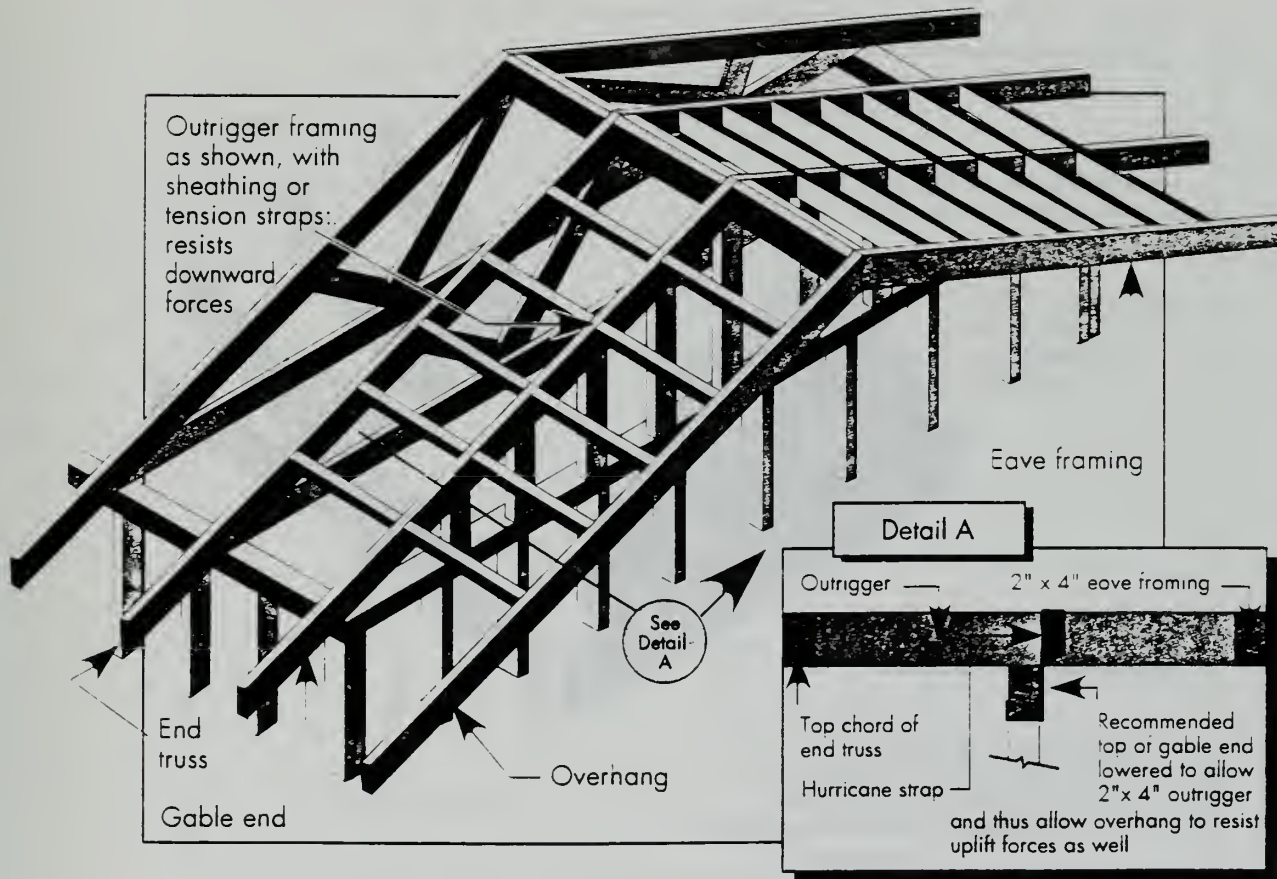

FIGURE IV-C
ROOF BRACING FOR GABLE ROOF OVERHANG

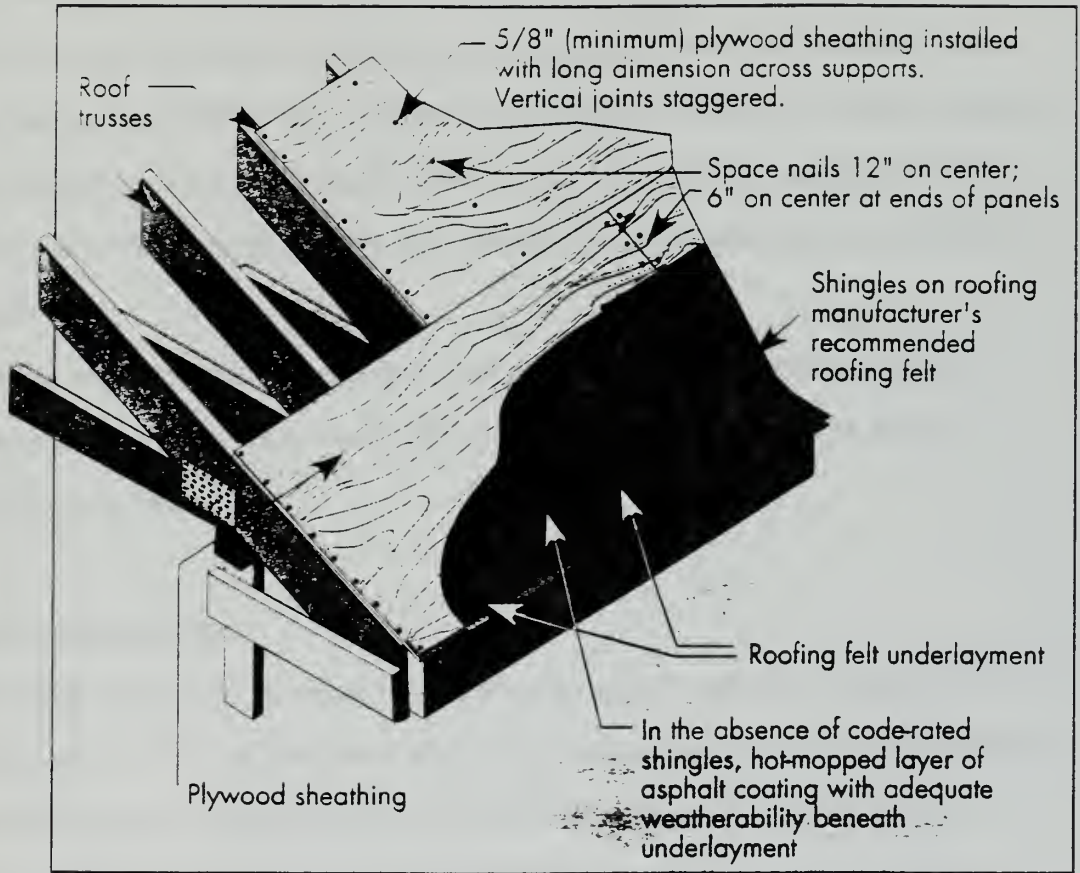

FIGURE IV-D
COMPOSITION SHINGLE ROOFING SYSTEM

Once all of the roof tile is laid up completely, traffic should not be allowed on the roof for 72 hours, and no work should be done on the structure for 24 hours in order to allow the tile to properly set without vibration of the roof framing or sheathing. Finally, all flashings should be sealed to the subroof for water tightness.

6. The design of more aerodynamic building shapes is highly recommended. In particular hip roof systems are much less susceptible to damage from direct perpendicular wind as well as swirling wind flows which accumulate at corners and edges of building. With the poor performance of gable end roofs and the required bracing that accompanies them to prevent severe wind damage, an inherently braced hip roof makes much more sense (see Figure IV-E).

7. Venting with adequate openings should be provided to relieve internal pressures on roof structures. Venting must be installed in a manner which prevents the entry of uncontrolled air flow.

Exterior Wall Openings

1. Double car garage doors should be avoided in design or held secure during a storm. Installation of 2" x 4" girts and metal mullions on two-car garage doors also are valuable in providing proper stabilization of the wide spans (See Figure IV-F, IV-G, IV-H). In addition, gliding tracks and track supports should be strengthened to prevent failure caused by door deflection (See Figure IV-I).

2. Window design should allow for protection from shutters or precut plywood (See Figures IV-J & IV-K).

3. Exterior doors, particularly double doors, should be built to withstand the design wind load and should be rated according to wind resistance.

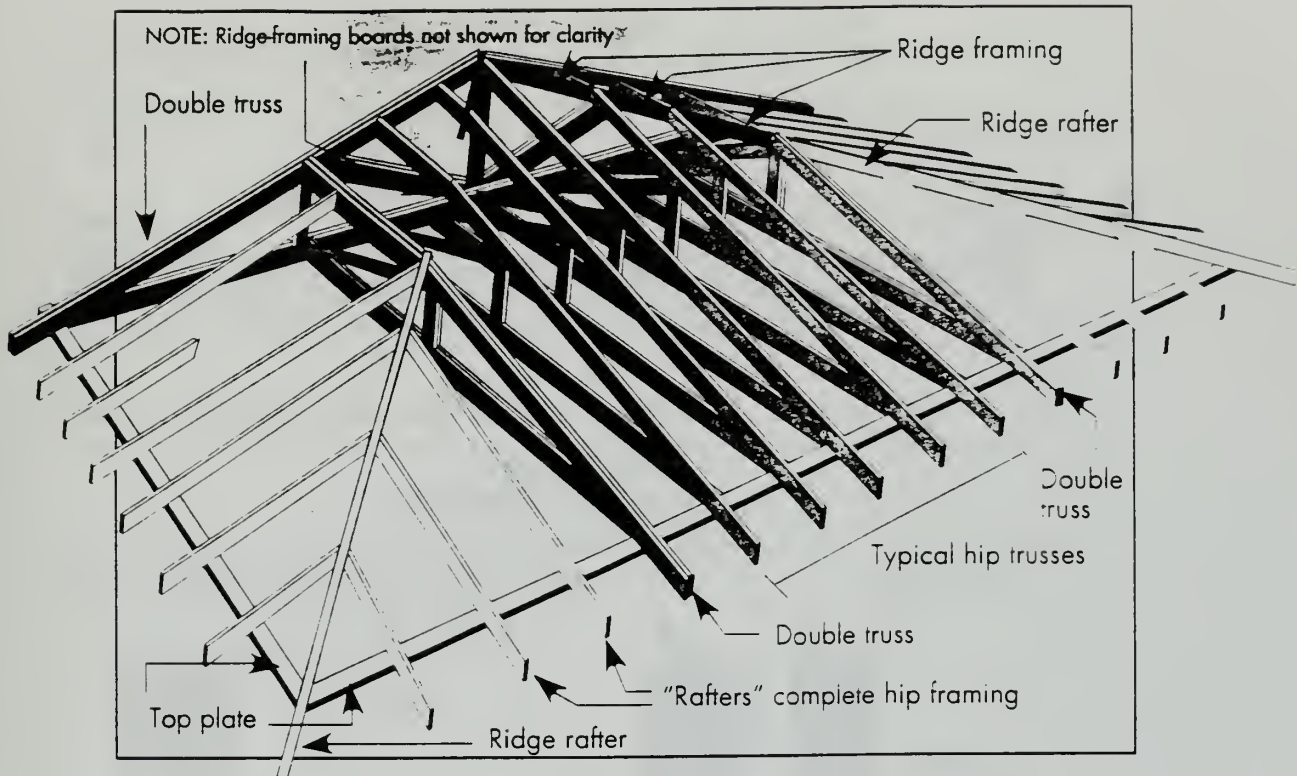

**FIGURE IV-E
HIP ROOF FRAMING**

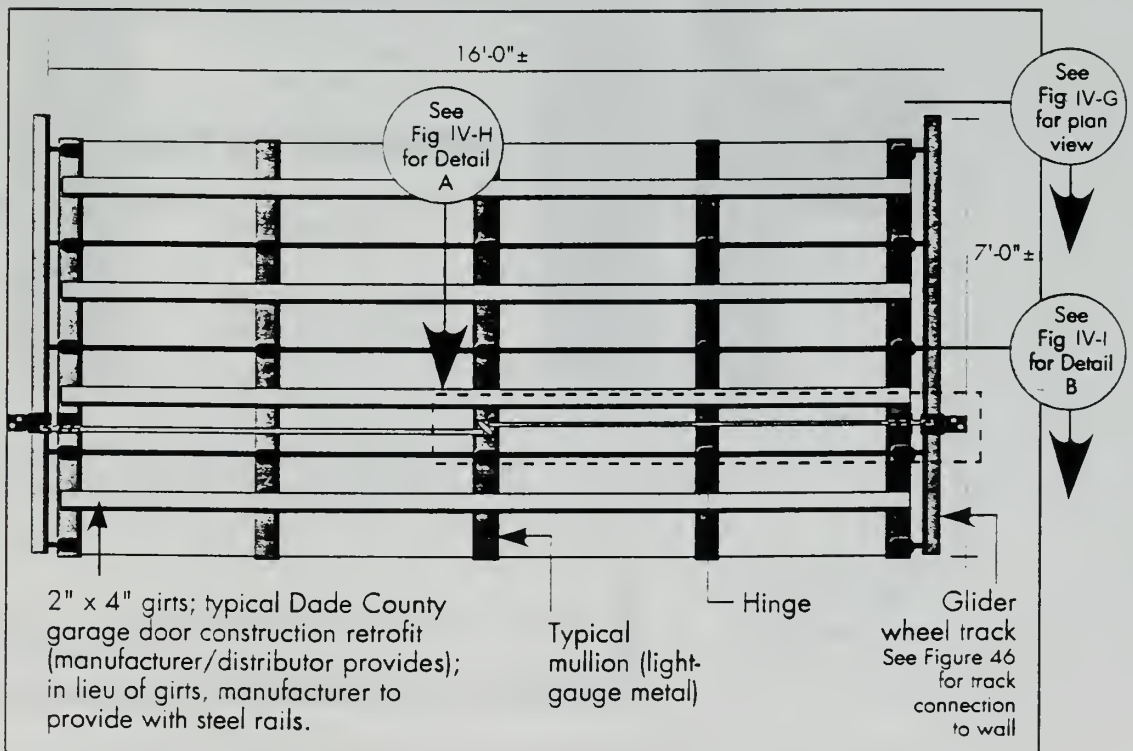

**FIGURE IV-F
GARAGE DOOR ELEVATION**

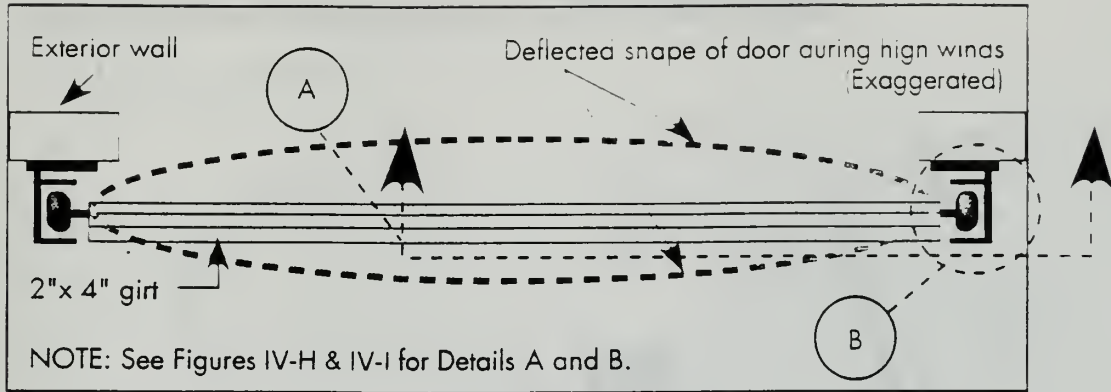

**FIGURE IV-G
GARAGE DOOR PLAN VIEW**

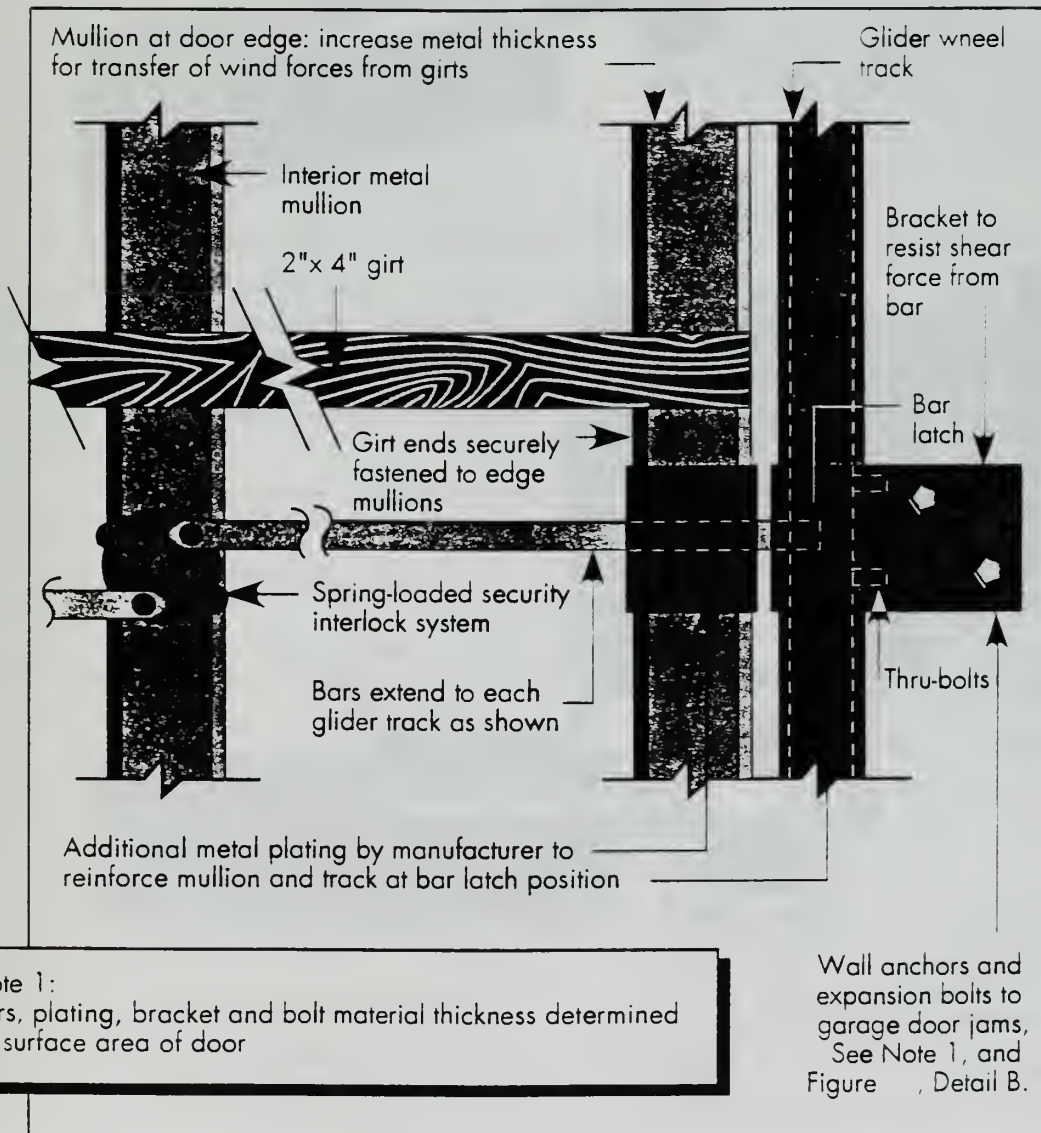

**FIGURE IV-H
GARAGE DOOR REINFORCED HORIZONTAL LATCH SYSTEM**

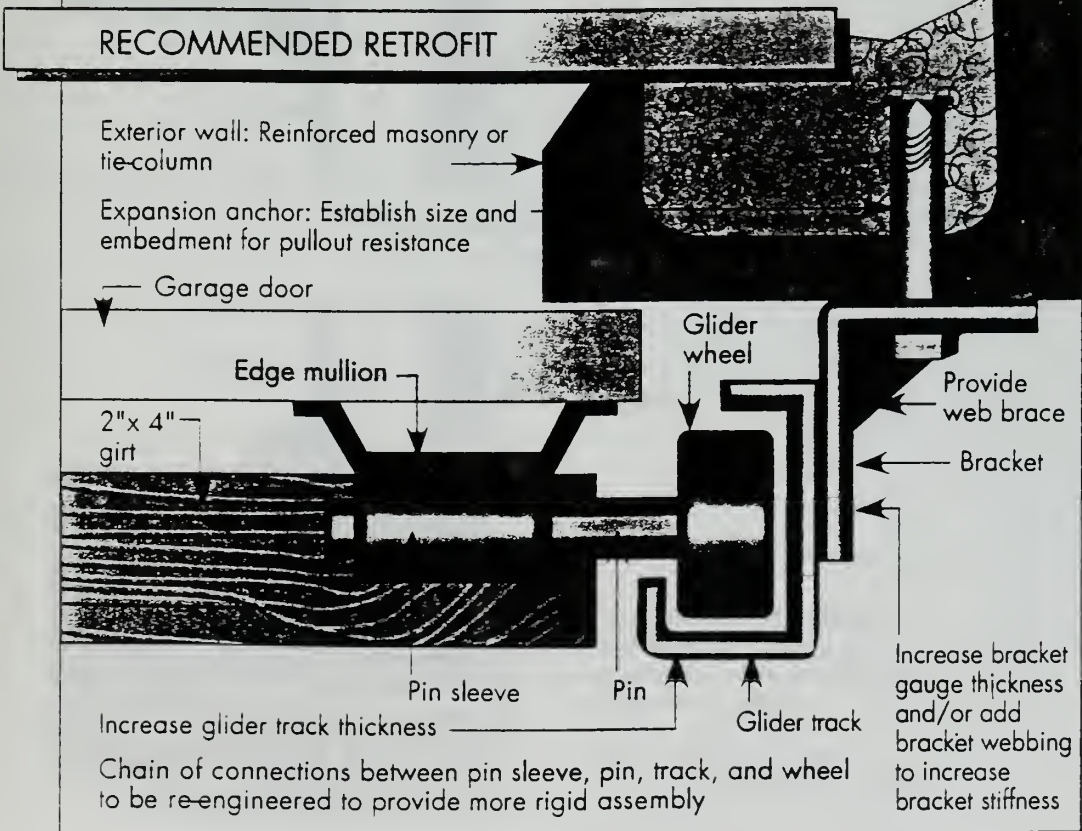
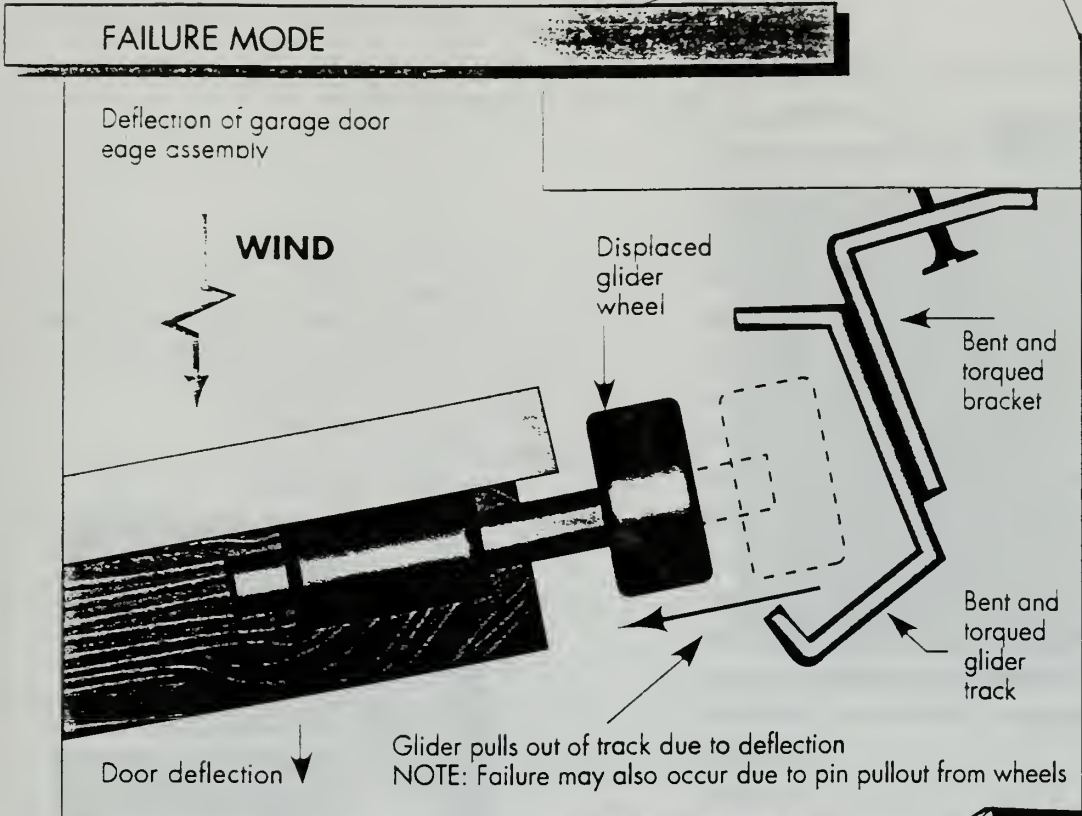

**FIGURE IV-1
GARAGE DOOR FAILURE & RETROFIT**

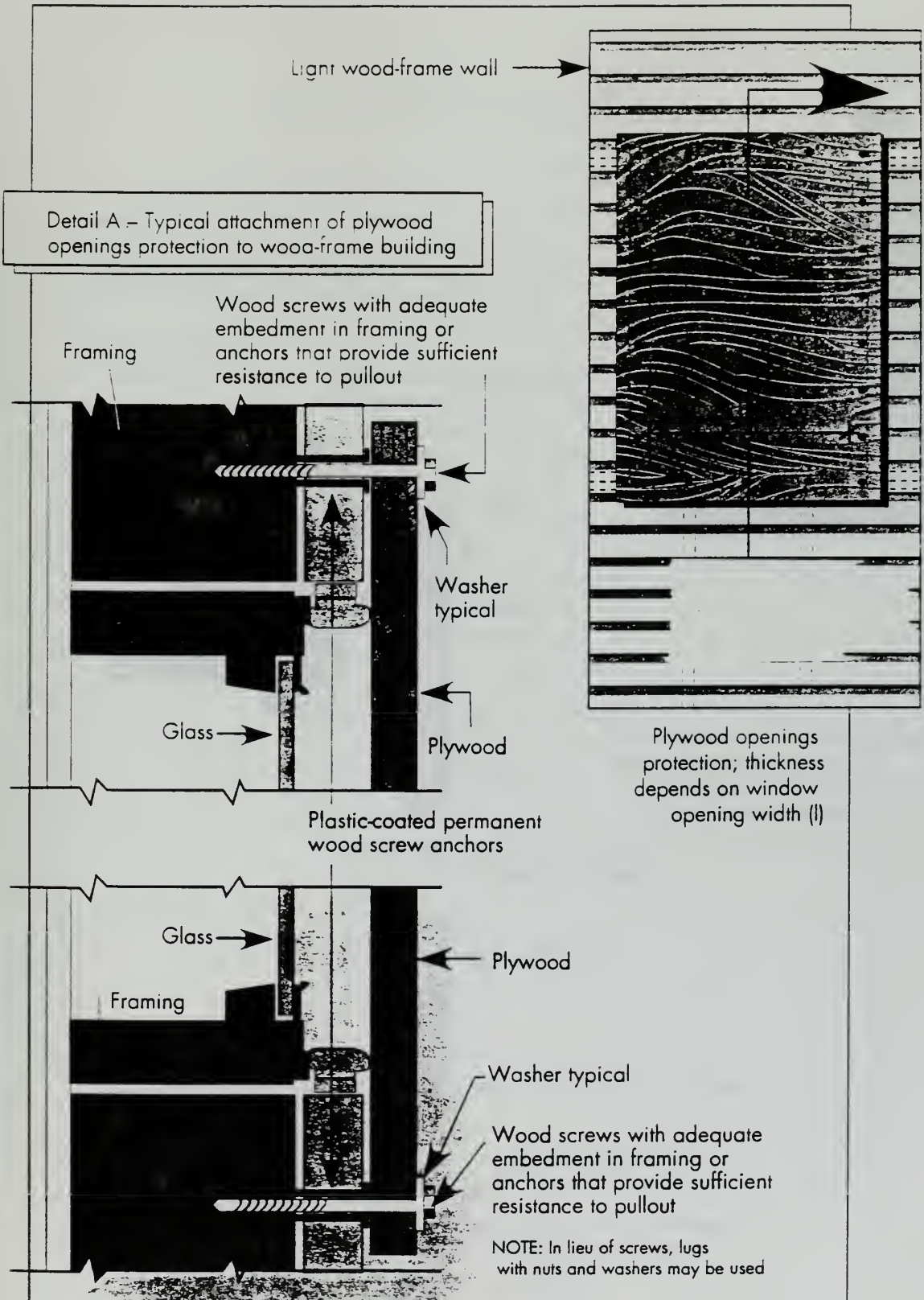

FIGURE IV-J
 PLYWOOD PROTECTION DETAILS - WOOD-FRAME BUILDING

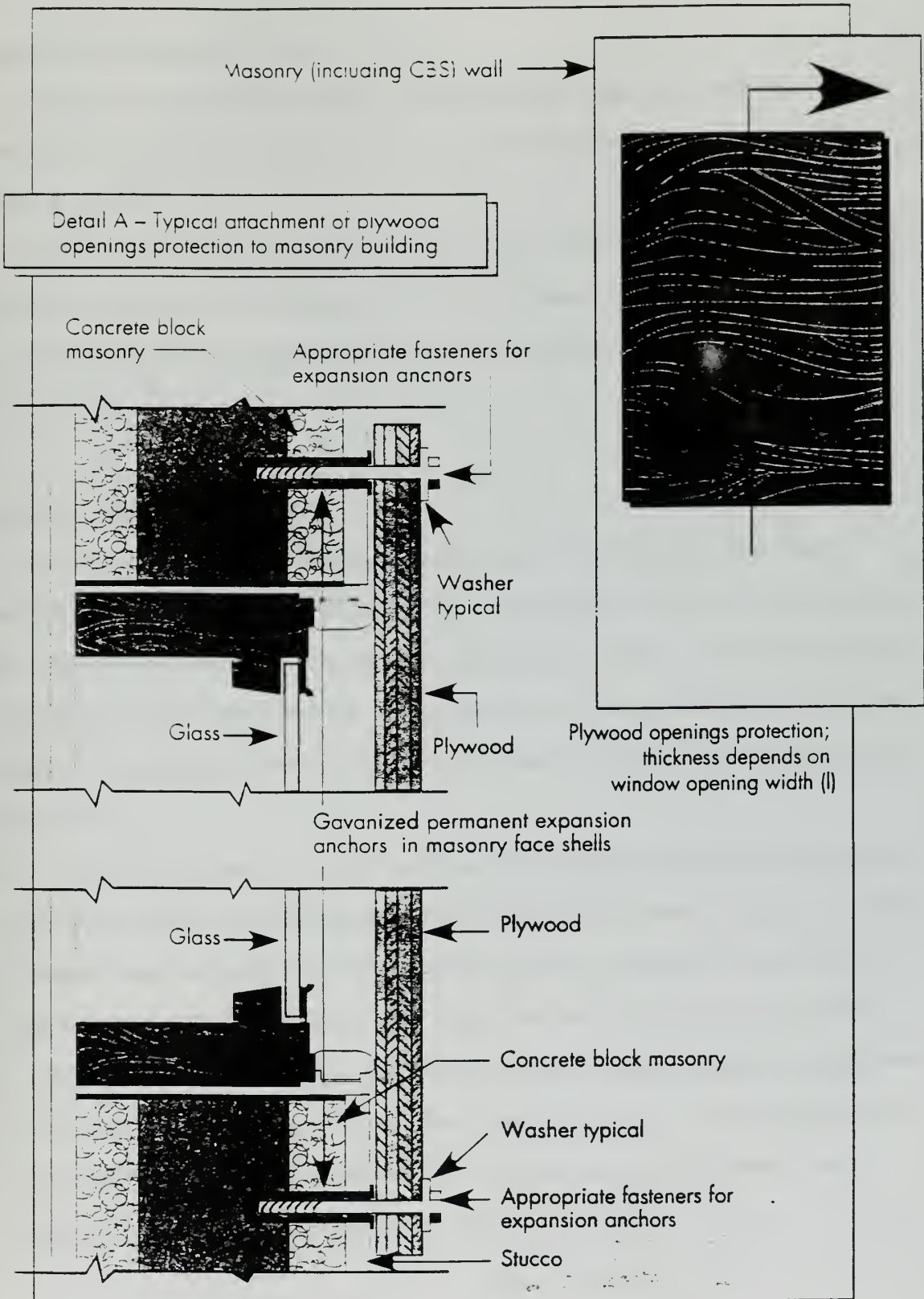

FIGURE IV-K
PLYWOOD PROTECTION DETAILS - MASONRY BUILDING

Light Wood-Frame Buildings

1. Designers and plan reviewers should take greater care regarding lateral load transfer mechanisms because of the high lateral loads generated by hurricane winds (See Figures IV-L & IV-M).
2. During construction, much greater attention should be paid to the proper installation of all lateral load transfer mechanisms inherent in conventional building framing. Workers should be trained in the proper installation of these mechanisms (See Figures IV-N & IV-O).

Masonry Buildings

1. Code requirements for tie beam/tie column construction should be more strictly enforced. Reinforced concrete tie-beams should be placed in all walls of unit masonry, at each floor or roof level. Tie-columns at all corners and at all intervals of 20 feet should be considered as a Code improvement. The maximum area of wall panel between structural members (tie-beams and tie-columns) framing the panel should not exceed 256 feet. (See Figure IV-P).
2. Continuous tie-beams in masonry walls should be designed and constructed to support the specific architecture of the structure (See Figure IV-Q). Bracing with struts or pilaster columns in walls perpendicular to the freestanding walls, or sufficient reinforcing in the walls anchored in the foundation or story below, also must be engineered and installed.
3. Much greater attention must be paid to the transfer of loads to slabs and masonry walls from wood framing (See Figure IV-R). Bolted masonry-to-wood connections must be used in all cases, and shortcut practices such as cut nails must be eliminated. Finally, masonry to wood straps must be properly located.

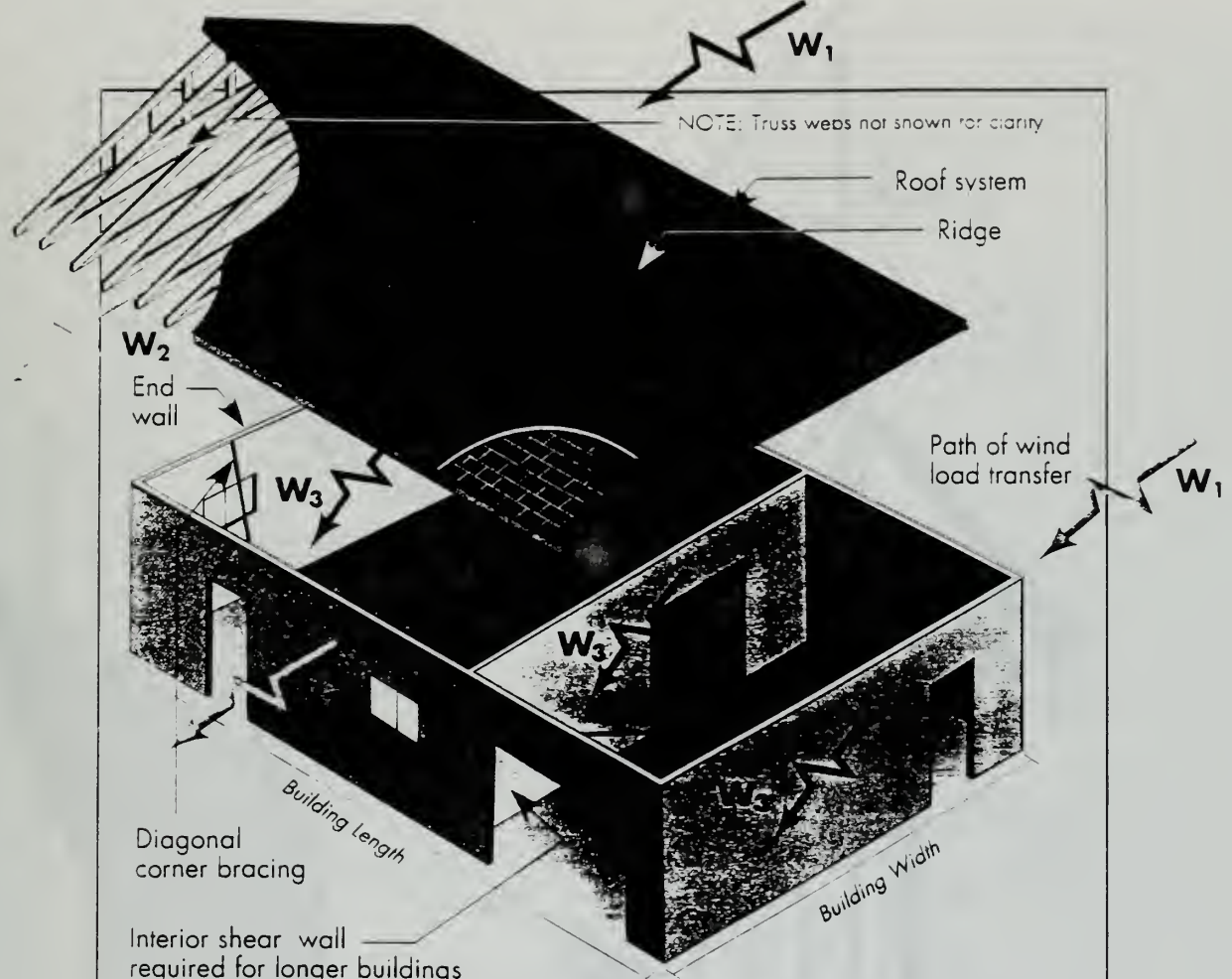

External lateral wind forces act on windward walls and roof (W_1) and in suction on leeward walls and roof (W_2). End shear walls and interior shear walls permit transfer of these forces to base of building (W_3). Base shear forces (W_4) transfer into foundation system. Ground resists final transfer of lateral forces (W_5). (Total $W_1 + W_2 = \text{Total } W_3 + W_4 = \text{Total } W_5$)

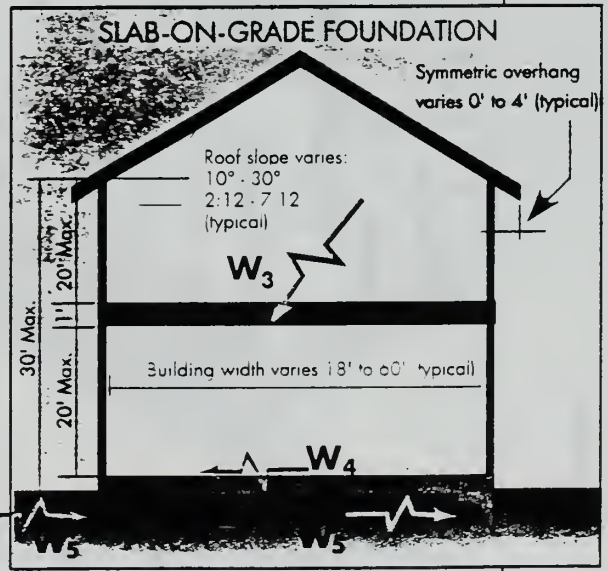
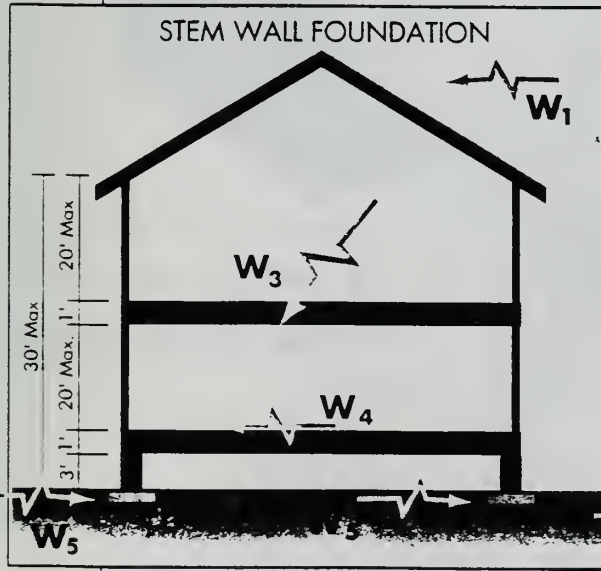

FIGURE IV-L
TYPICAL LATERAL LOAD TRANSFER

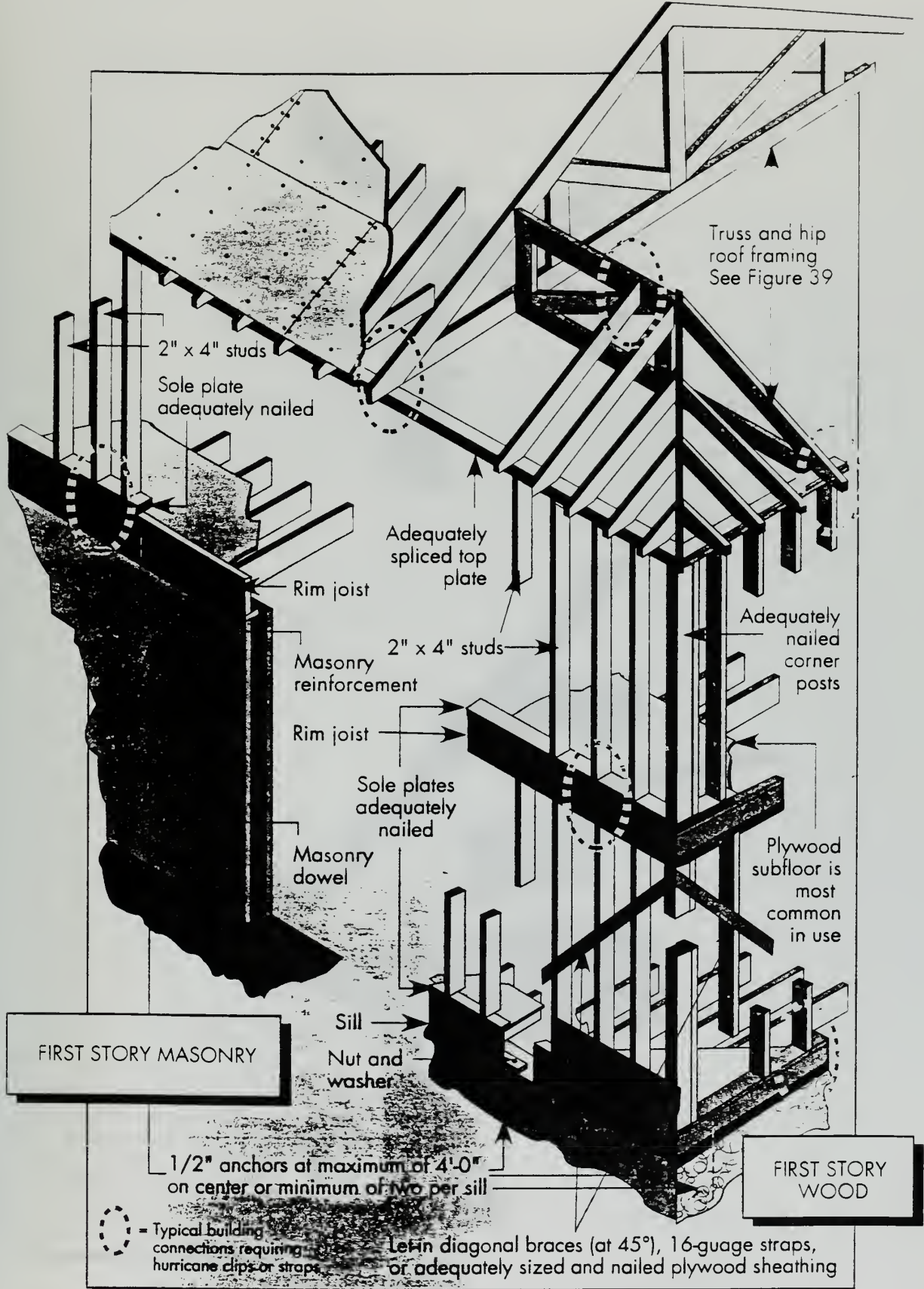

FIGURE IV-M
PRIMARY WOOD FRAMING SYSTEMS

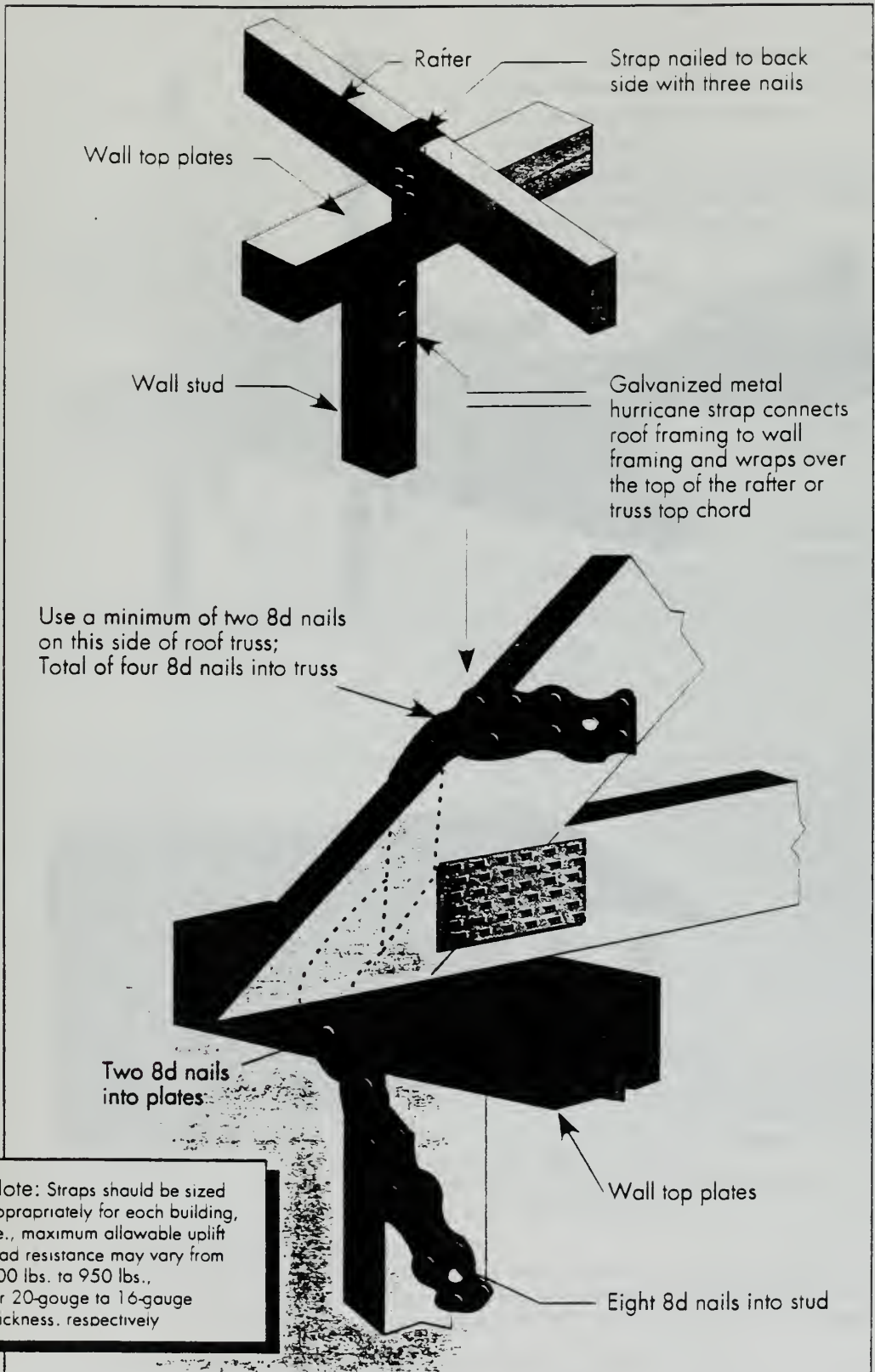
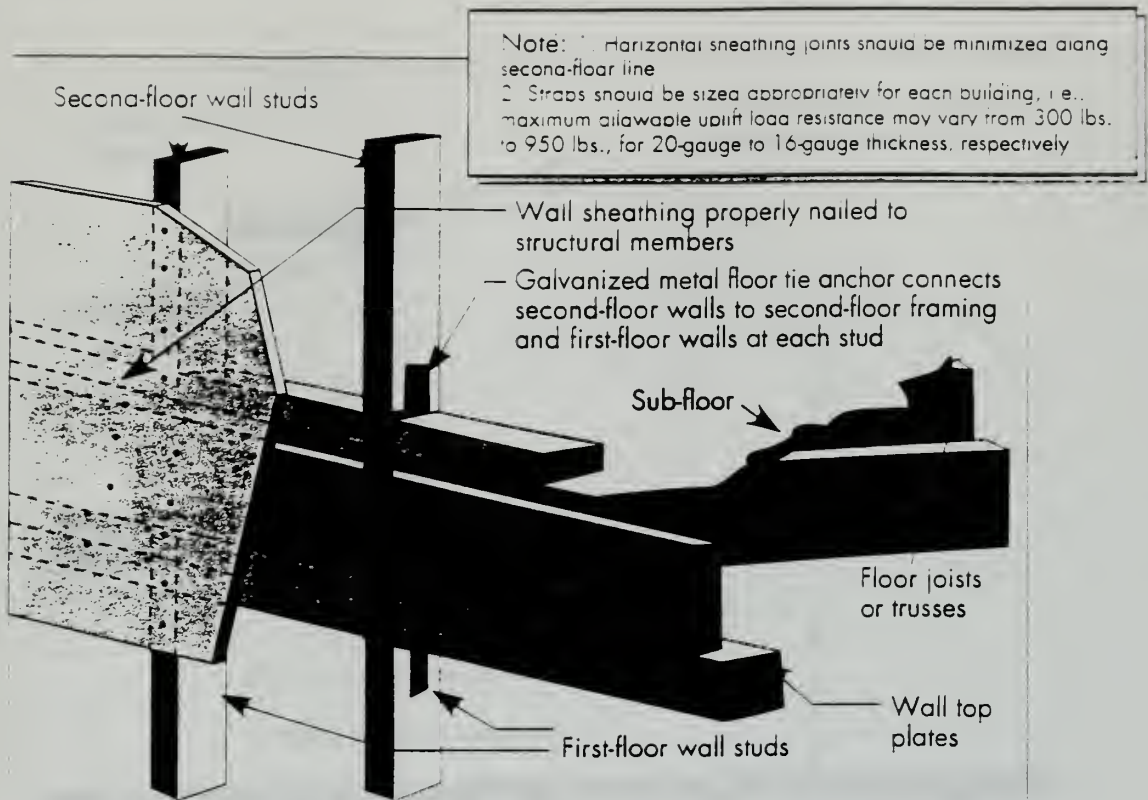
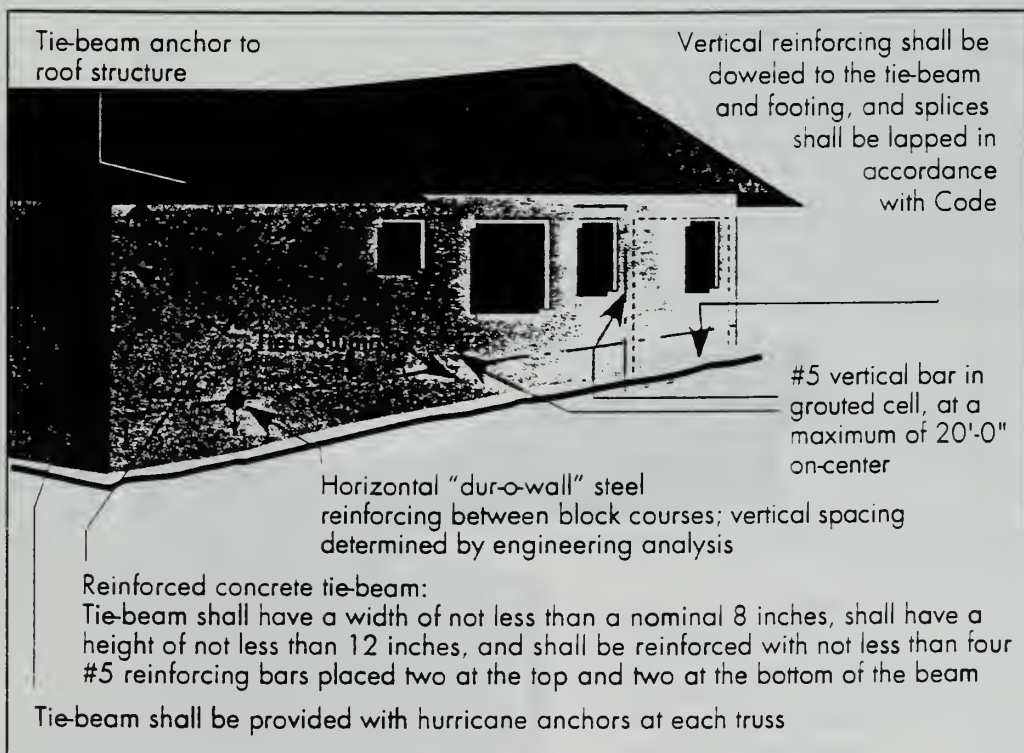

FIGURE IV-N
HURRICANE STRAPS - RAFTER OR ROOF TRUSS



**FIGURE IV-O
FLOOR TIE**



**FIGURE IV-P
TIE BEAM/TIE COLUMN - MASONRY WALL**

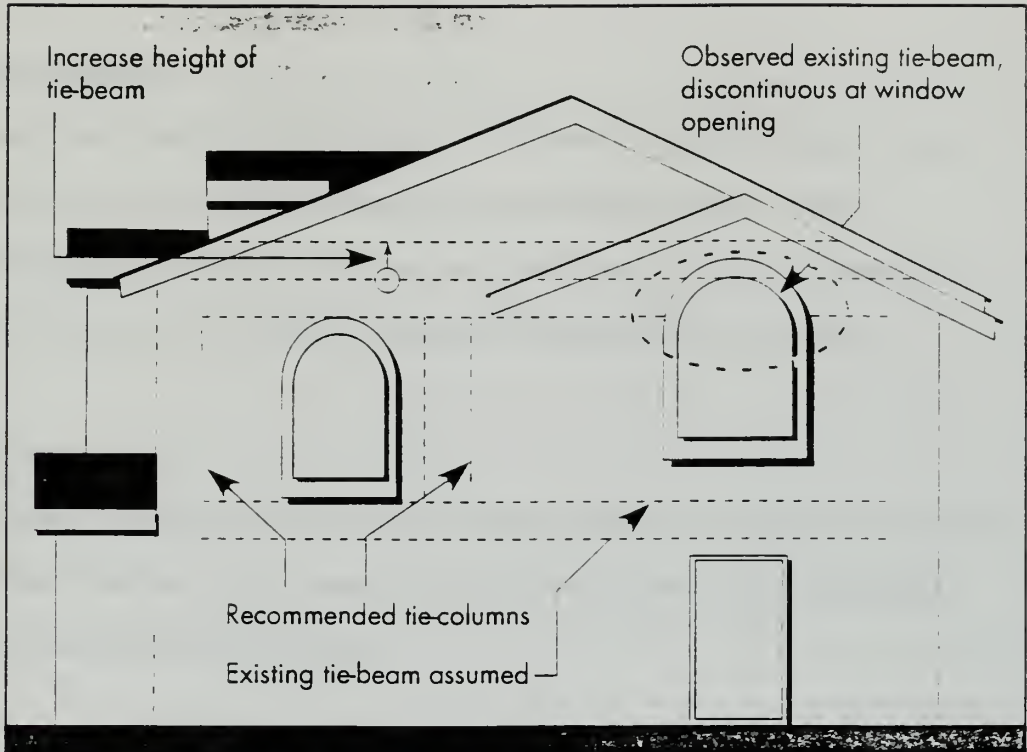

FIGURE IV - Q
STRUCTURAL SUPPORT FOR ARCHITECTURAL SYSTEM

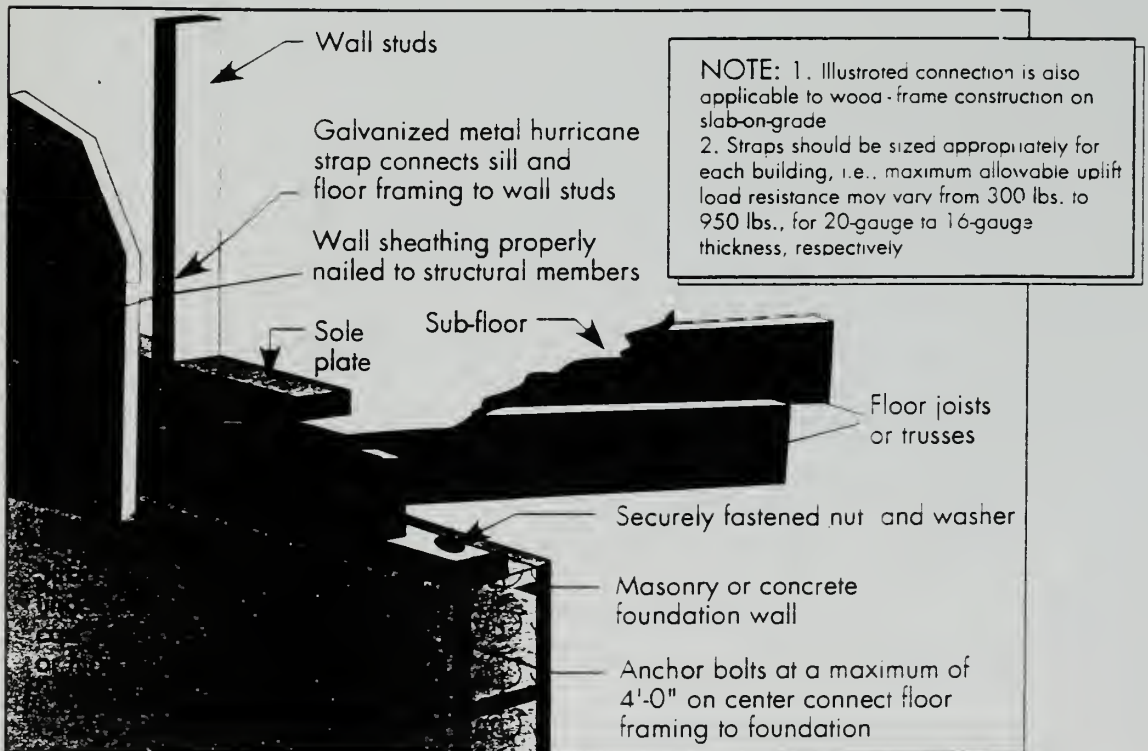

FIGURE IV-R
WALL ANCHORAGE TO MASONRY BASE

Modular Buildings

1. Strengthening the end walls of modular type homes should be considered. This is especially important in those structures which have gable end walls. Earlier recommendations regarding roof systems, especially those referring to diagonal and horizontal bracing, are particularly applicable in modular building end walls.

Accessory Structures

1. Accessory structures should be designed, manufactured, and installed to withstand winds greater than the 75 mph currently required for such items as porch framing, lightpoles, and playground equipment.

CHAPTER V

SUMMARY OF SBCCI STANDARD FOR HURRICANE RESISTANT RESIDENTIAL CONSTRUCTION, SSTD 10-93

Overview

In an effort to understand the required engineering aspects of hurricane preparedness for residential structures, it is helpful to be familiar with the applicable building code which currently applies to the southern United States, where hurricanes are most prevalent. SSTD 10-93 is the Southern Building Code Congress International (SBCCI) standard which sets prescriptive methods for wind resistant designs and construction details for one- and two-story residential buildings of conventional, wood-framed and masonry construction in potentially high wind areas. The requirements are deemed to comply with load provisions of Section 1205 of the 1991 edition with the 1992/93 revisions of the Standard Building Code (SBC).

SSTD 10-93 is divided into four chapters: 1 - General Requirements; 2 - Buildings with Masonry Exterior Walls; 3 - Buildings with Wood-Framed Exterior Walls; and 4 - Combined Wood and Masonry Exterior Wall Construction. The following summary will encompass all four chapters but will focus on the items which apply to the prevalent damage found in major hurricanes which was detailed in Chapter III of this report.

Chapter 1 General Requirements

This chapter outlines various considerations in building design as they pertain to hurricane preparedness. There are sections pertaining to the integrity of the building envelope as well as building geometry, foundations, and classification of wind loads. Geometric limits are set for building widths depending upon the number of stories as well as roof slopes, eaves heights, and several other important measurements. The standard applies to buildings with slab-on-grade, pile, and concrete footing foundations, and it

specifically addresses residential structures that fall within Coastal High Hazard Areas and Special Flood Hazard Areas.

Regarding wind loads, the Code prescribes requirements based upon the Standard Building Code for buildings less than 60 feet in height. The winds loads are separated into the overall forces used in the design of Main Wind Resisting Systems (MWFRS) and loads appropriate for the design of fasteners, cladding, and other small areas of potentially high loads. These loads are known as Component and Cladding (C&C) loads. The Code provides prescriptive requirements for buildings sited in three separate wind climates (90, 100, and 110 mph) as shown on the map in Figure V-A.

Chapter 2 - Buildings with Masonry Exterior Walls

This chapter prescribes construction requirements for buildings where all exterior walls above the foundation are masonry and where the building meets the requirements of Chapter 1. Interior walls may be masonry, wood framed, or any other approved construction.

The chapter initially prescribes the standards for masonry units: composition, size, reinforcing steel, and accessories. It also discusses the requirements for mortar and grout used in conjunction with masonry installation.

One of the most important aspects of this chapter is the section dealing with fasteners and connectors. It prescribes a continuous load path between foundations, walls, and roofs, and it requires approved anchors, connectors, and other fastening devices able to withstand forces in the Standard Building Code. This section also prescribes requirements for reinforcing steel within the masonry, cleanout openings, and grouting.

A section is devoted to the proper design and construction of floorings and foundations. Under design, the Code requires all exterior walls, bearing walls, and columns to be supported by concrete footings of sufficient design to safely support the

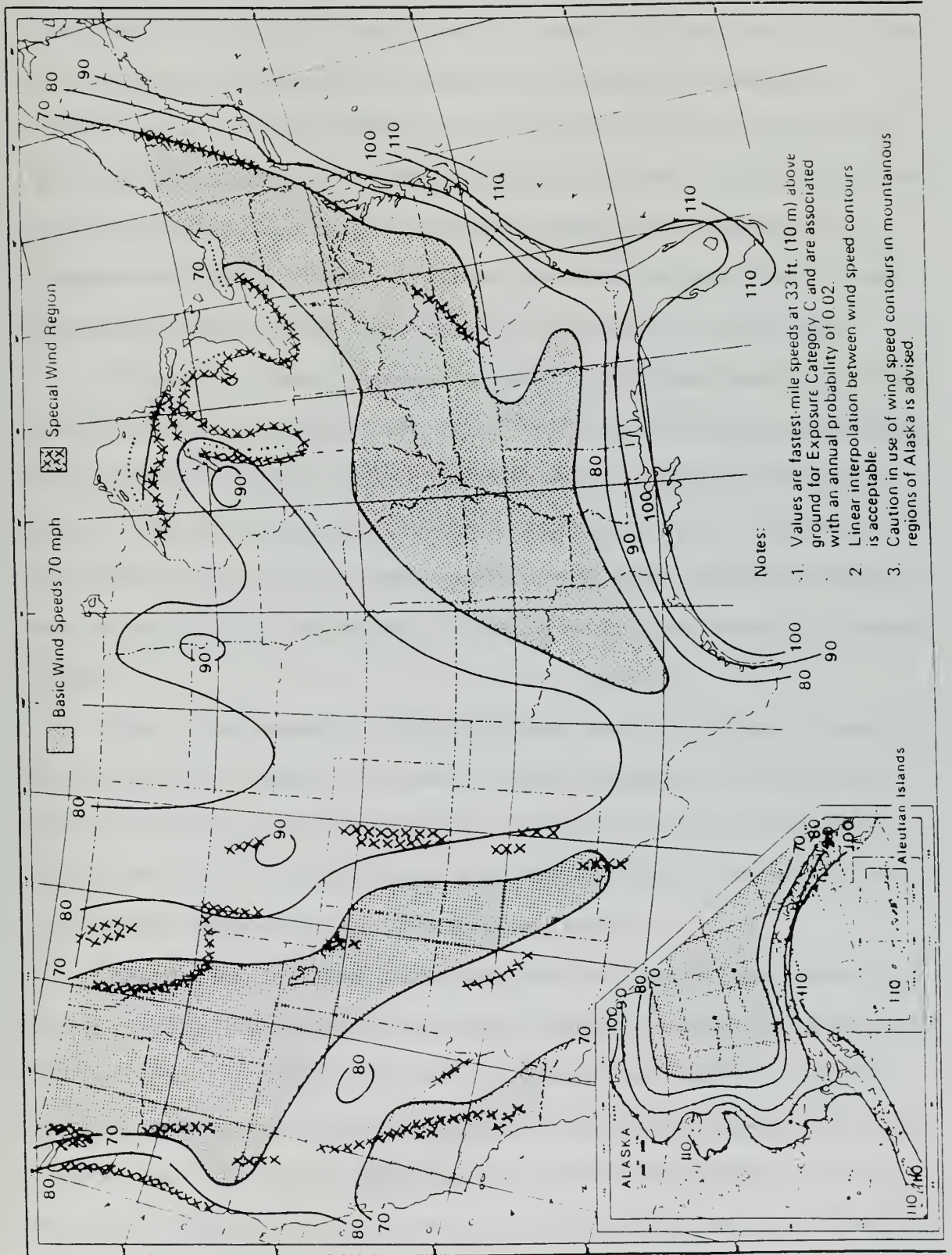

FIGURE V-A
BASIC WIND SPEED MAP

loads imposed. Regarding construction, the Code details specific requirements for items such as the depth of footings, width of footings, reinforcing steel, and thickness of stemwalls. This section also defines the requirements for concrete slab-on-grade design and construction, suspended slabs, and wood frame floor systems. For wood frame floors, specific requirements for joists, trusses, sheathing framing, blocking, fastening, and connections are detailed. This section also sets standards for suspended floors to resist lateral forces applied to exterior walls since the floors act as structural diaphragms.

The section on masonry delineates requirements for thickness (generally, 8 inches) as well as those for bond beams. It also breaks down vertical reinforcement requirements for wall systems according to which wind zone the structure is sited. For continuous masonry with gable end walls, the standard is for the masonry to run to the full height of the roof line with a bond beam at the top of the masonry. Finally, lintel and bond beam requirements above wall openings such as doors and windows are discussed and outlined in detail.

There is a requirement for a ceiling diaphragm when a gable endwall of masonry is not constructed to full height. In the case of no ceiling diaphragm such as a cathedral ceiling, continuous masonry must be installed to the roof line. No ceiling diaphragm is required with a hip roof. Ceiling frames are also discussed in this section as well as the use of gypsum wallboard and plywood as diaphragm materials.

A section describes rafter-joist framing systems including materials, spacing, ridge boards, and collar beams. Truss systems are also discussed including conformity with the TPI Design Specification for Metal Plate Wood Trusses. Roof sheathing is covered in detail with specific requirements for 8d common or 8d hot dipped galvanized box nails at 6 inches on center at edges and 6 inches on center at intermediate framing with some exceptions. Specific bracing for roof sheathing is called for when a gable endwall extends from the floor to the roof sheathing without support from a ceiling diaphragm. There are

also standards for roof diaphragm shear capacity at sidewall, endwalls, and interior shearwalls, depending upon factors such as building width as well as the appropriate wind zone. Connections for wood roof systems to sidewalls are discussed in great detail with specific requirements for attachment to bond beams as well as bolted top plates (See Figure V-B & V-C). Different standards for gable endwalls are presented as well as hip roofs. Interior shearwall connections to the roof are required to meet the same requirements as endwalls.

Chapter 3 - Buildings with Wood-Framed Exterior Walls

This chapter prescribes construction requirements for buildings where all exterior walls above the foundation are wood framed. This type of construction is found at one of the three Navy bases studied in later chapters of this report.

The chapter contains sections on fasteners and connectors, as well as footings and foundations, which are very similar to the requirements in Chapter 2. There is also a detailed discussion with diagrams regarding stemwall foundations, including restrictions on footings, masonry foundation walls, floor and wall anchorage.

Another section discusses monolithic slab on grade foundations including wall anchorage for different wind zones, holddown connectors, and interior footings. Wood pile restrictions pertaining to uplift and shear loads on piles and girders are also detailed as well as pile connections.

Floor systems, including concrete floors and wood floors are discussed in the next section. Thickness and reinforcement requirements for concrete floors are established. Wood floors are discussed in great detail including descriptions and restrictions for floor joists, trusses, sheathing, framing, and connections. A table shows required floor diaphragm shear capacities depending upon wind zones and distance between shear walls, and another table displays the shear capacities for common diaphragm materials depending upon nail spacing and provided bracing.

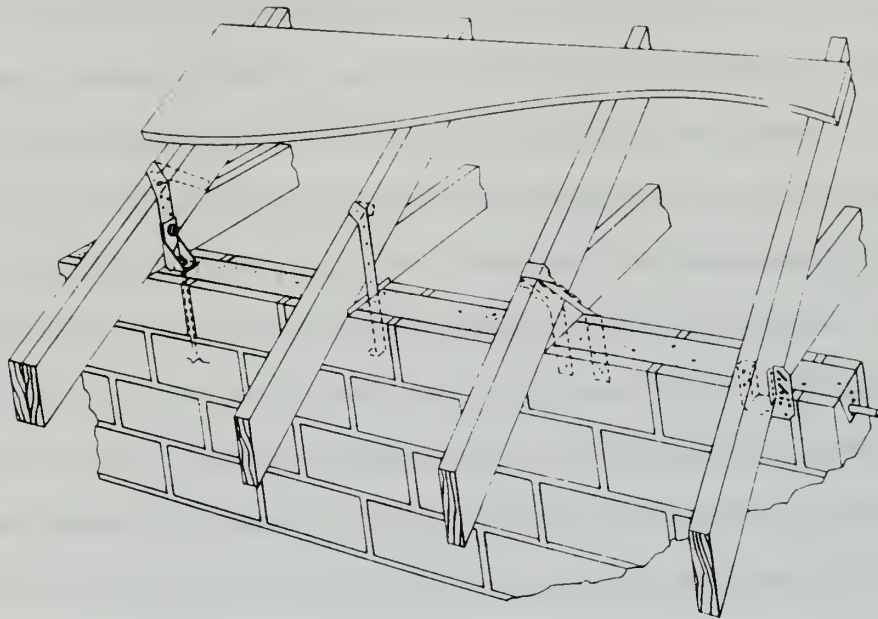

FIGURE V-B
ROOF TO MASONRY SIDEWALL CONNECTION
DIRECT TO BOND BEAM

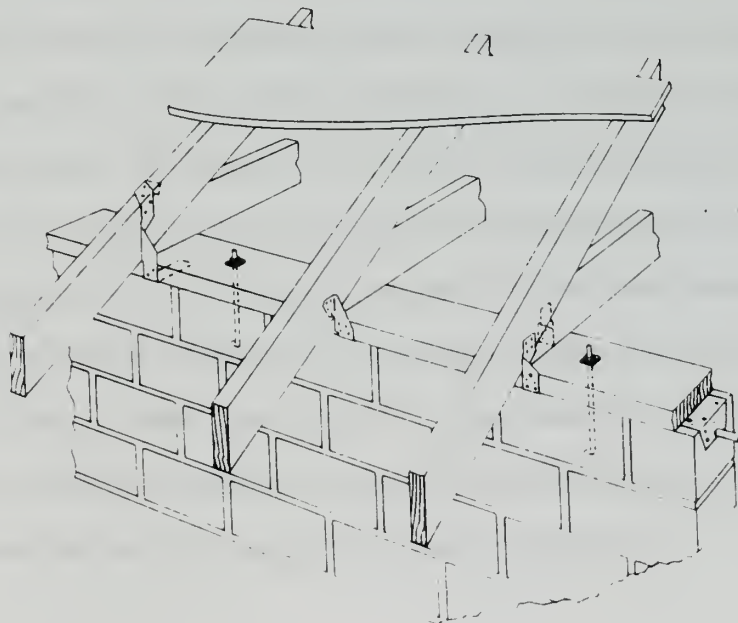

FIGURE V-C
ROOF TO MASONRY SIDEWALL CONNECTION
BOLTED TOP PLATE ALTERNATE

Requirements for wood-framed wall systems are described in great detail in the next section. The minimum bending strength is the important consideration for wall studs, and tables display allowable values for various types and grades of lumbers, and required values for studs depending upon wind zone plus stud size, length, and spacing.

Connections for exterior wall framing are discussed including uplift connectors providing continuous resistance from roof to foundation. Tables show the allowable uplift loads for sidewalls depending upon wind zone, building width, plus roof and ceiling load. There is a separate table for gable endwalls with much lower allowable uplift loads. Figures V-D, V-E, V-F, and V-G show typical wall connections to roof systems and floor levels.

Ceiling systems are presented with similar requirements to masonry construction. Just as the masonry units must go to the roofline for a gable endwall, in wood-frame construction, the wall studs must also extend all the way to the top or a ceiling diaphragm would be required (See Figure V-H).

Roof systems are described in great detail with particular attention paid to truss framing systems, bracing, roof sheathing, and the roof diaphragm. Trusses are to be spaced 24 inches on center, and connectors must be installed at truss bearing to resist uplift loads as specified in a provided table depending upon wind zone, roof and ceiling load, and building width. See Figures V-I and V-J for typical wood-frame connections. When a gable endwall extends from the floor to the roof sheathing and is not supported by a ceiling diaphragm, endwall roof bracing is required to be provided perpendicular to the rafters or trusses in the first two rafter or truss spaces at each end and must be spaced a maximum of four feet on center (See Figure V-K). Roof sheathing requirements mirror those of masonry buildings concerning materials and nailing requirements. Roof diaphragm requirements are also very similar to masonry structures.

Chapter 4 - Combined Masonry and Wood Exterior Wall Construction

This chapter deals with structures with combined wood frame and masonry wall elements. There are really no specific requirements for this type of building. Instead, the applicable standards from the previous chapters apply depending upon the building design.

For buildings with masonry on the first floor and wood frame second story, the foundation and first floor walls must correspond to the requirements for a masonry structure. Meanwhile, the second story floor system, walls, ceiling, and roof must be in accordance with the appropriate sections from Chapter 3 on wood-frame construction.

Homes with wood-frame gable endwalls above masonry walls are not permitted unless there is a ceiling diaphragm as specified in Chapter 2 on masonry construction. Gable construction must conform to Chapter 3, but connections of walls, ceiling, and gables must meet standards of Chapter 2.

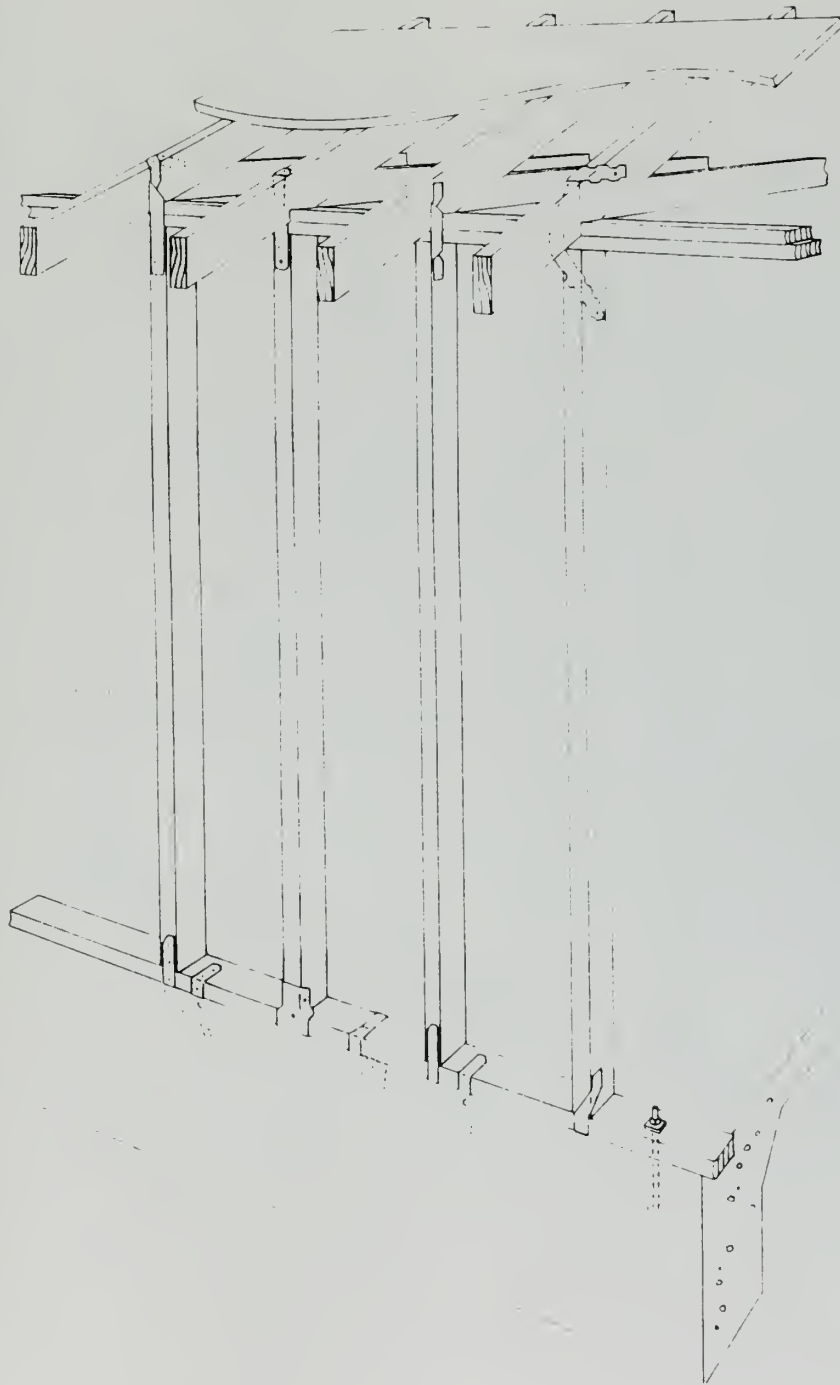

FIGURE V-D
TYPICAL WALL CONNECTIONS:
STUD SPACING SAME AS TRUSS/RAFTER SPACING

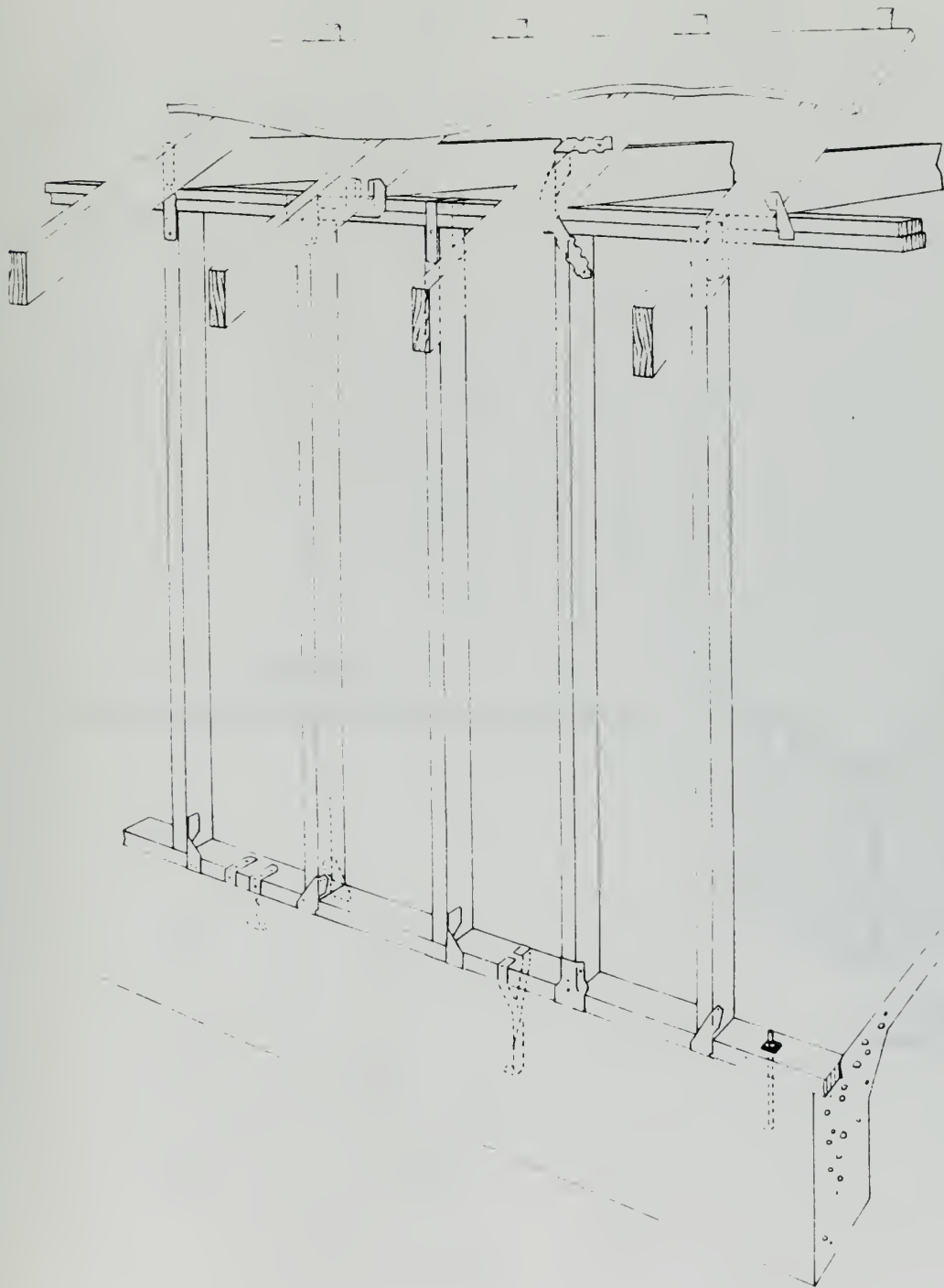

FIGURE V-E
TYPICAL WALL CONNECTIONS:
STUD SPACING DIFFERENT FROM TRUSS/RAFTER SPACING

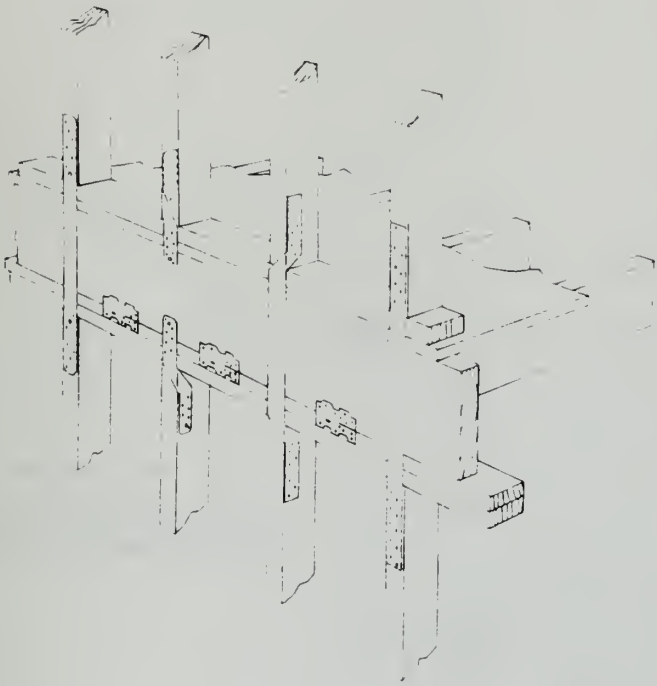

FIGURE V-F
CONNECTION DETAILS AT SECOND FLOOR LEVEL

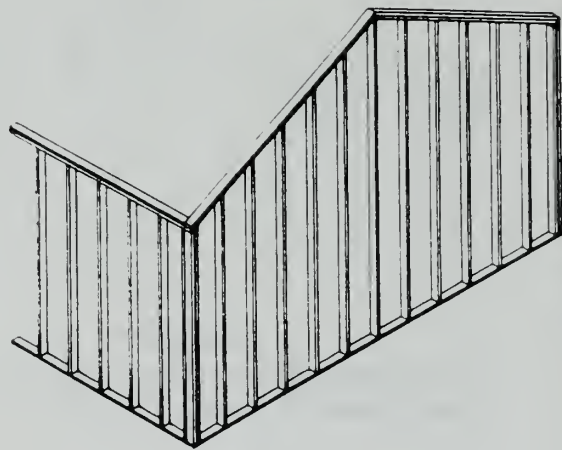

FIGURE V-H
GABLE ENDWALL

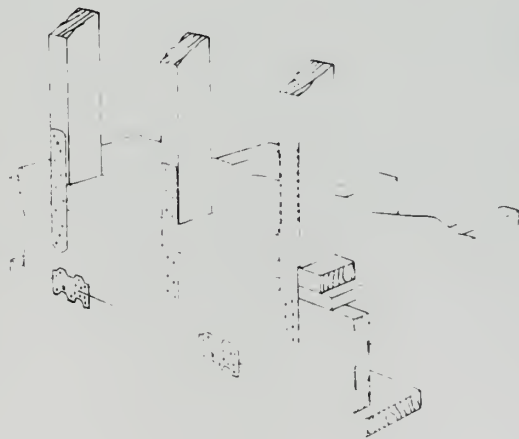

FIGURE V-G
CONNECTION DETAILS AT FIRST FLOOR LEVEL

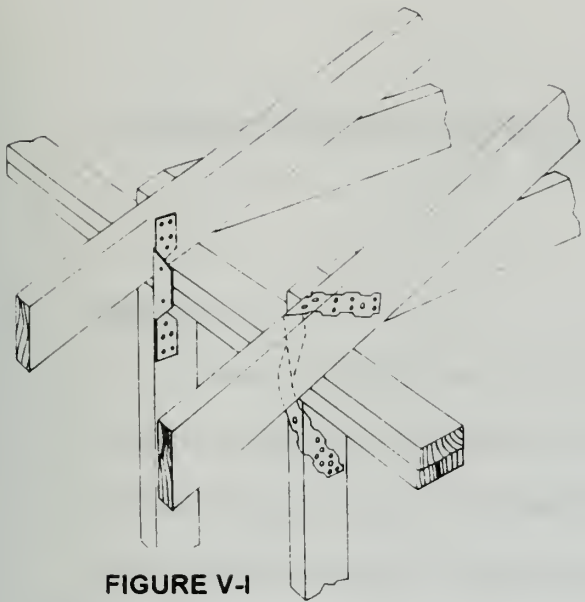

FIGURE V-I
RAFTER TO TOP PLATE
TO STUD CONNECTIONS

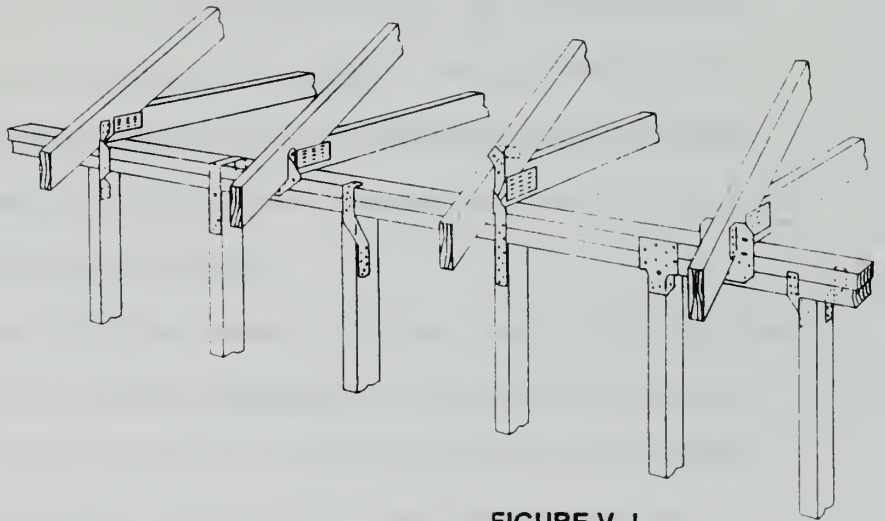

FIGURE V-J
TRUSS TO TOP PLATE CONNECTIONS AND
TRUSS TO TOP PLATE TO STUD CONNECTIONS

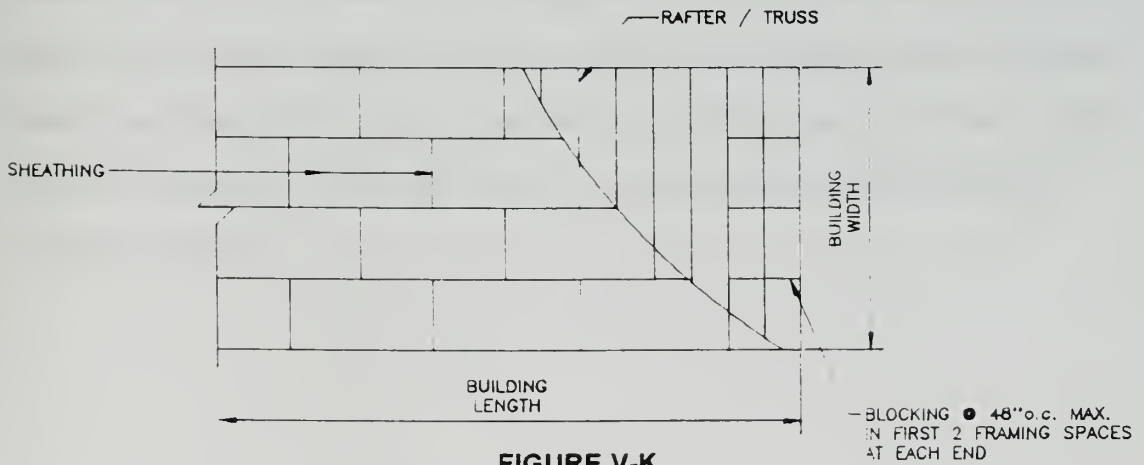

FIGURE V-K
ROOF SHEATHING LAYOUT
AND ENDWALL ROOF BRACING

CHAPTER VI EXISTING HURRICANE PREPAREDNESS CONDITIONS OF THREE NAVAL INSTALLATIONS

Overview

Three large Navy bases in the Jacksonville, Florida area were studied for this report on hurricane preparedness of Navy housing. The three bases are Naval Station Mayport (Mayport), Naval Air Station Jacksonville (NAS Jax), and Naval Submarine Support Base Kings Bay, Georgia (Kings Bay). The bases of Mayport and Kings Bay are situated on the coastline while NAS Jax is several miles inland. The Jacksonville area is obviously susceptible to hurricanes because of its location on the shore, but due to the indentation of the Atlantic Coast along the Georgia and northeastern Florida shorelines, this area is less likely to receive a direct hit than most communities in the Carolinas, south Florida, or along the coast of the Gulf of Mexico.

The existing conditions of the Navy housing on the bases was studied to determine the overall preparedness of the housing communities on base. Factors that were closely observed include proximity to the ocean, type of construction (masonry or wood frame), number of floors, type of unit (single, duplex, modular), wind protection from trees or other structures, roof systems and endwalls, age of units, garage door configuration, and exterior opening configuration. The housing structures at Mayport and NAS Jax are similar in that they are single story singles or duplexes with masonry exterior walls and shallow gable endwalls. Those at Kings Bay are generally duplex or modular two-story wood-frame buildings. Particular details of the housing facilities at each base are presented separately.

Naval Station Mayport

Naval Station Mayport is located slightly northeast of downtown Jacksonville, right on the Atlantic Ocean, and its housing structures are the most susceptible to the wind and water forces of a hurricane. Mayport has 681 housing units on the base itself with a few hundred others at nearby locations. For the purpose of this study, only those actually on the base were considered. The housing units at Mayport were built in the early 1960's. They are all one-story masonry wall structures. Some of the buildings are single units while most are duplexes.

The housing at Mayport is all in one area approximately half of a mile wide. The most eastern edge of the housing area is for senior officers and is essentially right on the beach. There is not a particularly large sand dune to protect from storm surge, but the units are at least a few feet above the shore elevation. There are some trees, but they are not of a number or type that would provide significant wind protection for the homes. As expected, the land is very flat.

The masonry structures appear to be in reasonably good condition. The walls themselves are painted with no siding on the walls. There are gable endwalls on nearly all of the units, and the masonry does not run all the way to the roof line. There is siding from the top of the masonry walls to the roof line. The gables are relatively small due to the shallow slope of the roofs (typically 2.5:12). The roofs were renovated approximately ten years ago and are expected to be replaced again in 15 years or so with new sheathing, shingles, and possibly roof trusses.

The duplex units do not have garages, but they do have carports. The single units, which are closest to the beach, have two-car garages with 18 foot wide garage doors. The homes generally have large window openings with no shutters and no easy way to affix protective plywood to the openings. There are generally three single doorway entries to each unit.

The most noteworthy deficiencies in terms of hurricane preparedness at Mayport is the lack of hurricane straps on the roof trusses and diagonal bracing at the endwalls. Even though the roofs are of very shallow slope, the existence of gable endwalls with no straps, particularly where the masonry does not go all the way to the roofline, makes the housing at Mayport very susceptible to severe roof damage and the interior water damage resulting from the roof failures.

Corrective actions that could be taken include the following:

1. Install hurricane straps and diagonal bracing as soon as possible. These actions would probably reduce the damage caused by a major hurricane by at least one half. It is likely that a Category III storm or higher would essentially destroy the current roof systems of nearly every housing unit on the base.
2. Install additional masonry units at the endwalls to the roofline. This could be done easily at the time of the next roof renovations.
3. Ensure minimum nailing requirements for roof sheathing, in accordance with SSTD 10-93, are met at the time of the next roof renovations, and ensure composition shingles rated for high wind areas are installed.
4. Install anchor positions to facilitate the rapid installation of plywood coverings on window openings. Purchase plywood and anchoring devices, store them at the individual units, and train the residents in the proper installation at annual hurricane preparedness briefs. Provide public works assistance in the installation process during evacuation preparations.
5. Install bracing on the garage doors in the single units. Also, perform a study on the condition of the door tracks and perform the necessary strengthening measures.
6. Monitor the sand dunes and consider raising the height of the dunes to provide greater storm surge protection.

Naval Air Station Jacksonville

Naval Air Station Jacksonville is located in the southern portion of Jacksonville, just north of Interstate 295 and on the western banks of the St. Johns River. It is approximately ten miles inland from the Atlantic Ocean, making it less susceptible to wind damage than Mayport. Storm surge itself is not a major concern for NAS Jax, but there is the potential for flooding from the river. NAS Jax has 318 permanent family housing units which were built in the 1970's and are somewhat similar to those at Mayport. The buildings are masonry wall structures but are mostly single unit structures, unlike Mayport. The roof systems have wood frame roof trusses with gable endwalls in which the masonry stops at the ceiling line as opposed to the roof line. Most of the housing is located in one area which is surrounded by fairly dense woods, thus providing some degree of protection from the wind but increasing the chance of damage from falling trees and broken branches.

Most of the housing units at NAS Jax are scheduled for renovation in the coming year. Several of the improvements are directly related to hurricane preparedness. Of greatest importance are the modifications to the roof systems. Most of the units will undergo the replacement of the entire roof systems including trusses, 5/8" plywood sheathing, and fiberglass shingles. The gable endwalls will remain as they are without continuous masonry to the roofline. The slope of the roof will be 1:2, significantly steeper than those at Mayport. The new plans call for diagonal bracing for the top chord of the roof trusses at each gable endwall, but there are no provisions for hurricane straps. Instead, galvanized metal framing anchors will be utilized to connect the trusses to the top plate. In addition, vinyl siding will be affixed to the existing masonry exterior walls.

Most of the housing units have carports instead of garages, and those with garages are only for one car. There are two fairly large window openings in the front of each house, and other smaller openings on the sides and in the rear. Vinyl shutters are provided

at each window opening, but the shutters are not large enough to provide protection for the larger window openings in the front. There are typically two single doorways for each housing unit.

The most pressing deficiency with regard to hurricane preparedness of the housing facilities at NAS Jax is the lack of hurricane straps. The gable endwalls are also a concern as are the large windows that cannot be protected by the shutters scheduled for installation in the coming months. On the whole, considering the inland location of the base, the housing units at NAS Jax are actually fairly well prepared for a major hurricane.

Corrective actions that could be taken include the following:

1. Install hurricane straps. The existing structures could probably withstand a Category I and possibly a Category II storm. Depending upon the weakening effect of landfall, a greater storm would likely destroy the renovated roof systems, as they are currently designed.
2. Install additional masonry units at the endwalls to the roofline.
3. Ensure minimum nailing requirements for roof sheathing in accordance with SSTD 10-93 are met at the time of the upcoming roof renovations, and ensure composition shingles rated for high wind areas are installed. Modify the contract if the current specifications do not conform to the Code.
4. Install anchor positions to facilitate the rapid installation of plywood coverings on the large window openings. Purchase plywood and anchoring devices, store them at the individual units, and train the residents in the proper installation at annual hurricane preparedness briefs. Provide public works assistance in installation process during evacuation preparations. This is of low priority, but the small cost of this suggestion would likely save damage to the interior of the homes.
5. Perform periodic surveys to check the condition of large trees near homes. Cut down trees showing signs of age that pose the threat of falling on housing units.

Naval Submarine Support Base Kings Bay, Georgia

Kings Bay is located near the town of St. Mary's, Georgia, approximately 15 miles north of the Georgia-Florida state line. The base is right on the coastline, but the housing structures are located in a remote wooded area about 2 miles inland. There are 665 family housing units at Kings Bay, and they were built in the late 1970's and early 1980's. The buildings are mostly duplex or 4-plex two-story wood-frame structures. The buildings typically have large gable endwalls and single car garages attached on the ends for each housing unit within. The garages also have gable endwalls. There are few trees actually in the immediate vicinity of the housing units, but the entire area is surrounded by tall, thin pines which provide some wind protection but also pose a potential threat of falling on the buildings.

The roof systems are similar to those at the other two bases. There are no hurricane straps and apparently no diagonal bracing at the top chord of the trusses near the endwalls. However, there is perpendicular bridging between the last three trusses on each end. The existing shingles are asphalt. From the drawings, it was difficult to definitively determine whether the exterior wall studs were continuous to the roofline of the buildings, so a safe assumption is that they do not. The exterior walls are covered by cedar siding on about half of the structures and brick veneer on the other half.

Most of the windows are fairly small but currently do not have shutters. Shutters could easily cover all window openings, but approximately half of the windows are situated very close to downspouts. Each unit has a single door in the front and a sliding glass door in the rear which leads to a deck or patio.

Once again, Kings Bay's most glaring discrepancy is the roof systems. The roofs are probably due for renovations in ten years or so, and several modifications could be made. Protection for the windows and sliding glass doors should also be considered in the

next renovation, and an assessment of the surrounding trees and the potential damage they could cause could be beneficial.

One final consideration is the existence of playground facilities located in the middle of housing sections. Playground equipment located in such positions that is not securely anchored to the ground could cause significant damage to the neighboring structures.

Corrective actions that could be taken include the following:

1. Install hurricane straps and diagonal bracing when the roof systems are renovated and as soon as possible. The present roof structures could probably withstand a Category I and, to some degree, a Category II storm. Depending upon the weakening effect of landfall, a greater storm would very likely destroy the entire roof systems.
2. Study the feasibility of installing exterior wall studs which extend from the second floor to the roof line.
3. Ensure minimum nailing requirements for roof sheathing in accordance with SSTD 10-93 are met at the time of roof renovations, and ensure composition shingles rated for high wind areas are installed.
4. Investigate the feasibility of moving the downspouts so that they would not interfere with shutters that could be installed to provide window protection. Also, install anchor positions to facilitate the rapid installation of plywood coverings on the sliding glass doors. Purchase plywood and anchoring devices, store them at the individual units, and train the residents in the proper installation at annual hurricane preparedness briefs. Provide public works assistance in the installation process during evacuation preparations
5. Perform periodic surveys to check the condition of tall trees near homes. Cut down trees showing signs of age that pose the threat of falling on housing units.
6. Perform a survey of playground equipment in the housing areas and determine if anchoring is secure to withstand at least Category II winds.

CHAPTER VII
LIFE CYCLE COST ANALYSIS OF NAVAL INSTALLATIONS

Overview

An important component in a study of a Navy base's hurricane preparedness is to consider the value of the suggested improvements over the life expectancy of the facilities in question. In order to do make this study more complete, a life cycle cost analysis of the housing units at each base must be done. The analysis must determine projected cost savings if the recommended actions are taken as opposed to if standard replacement of the existing roof conditions are performed periodically.

Each base was analyzed using rough estimates for the corrective actions listed in Chapter V. Those per unit costs were projected to be an expenditure in the year 2000. Periodic repairs, particularly to the roof systems, were projected to take place in 2025, and for uniformity sake, the life expectancy of the housing facilities at all three bases was estimated to expire in 2050. Estimated costs of planned roof repairs without the recommended corrective actions also are necessary for an accurate assessment. The estimated costs (projected at the time of repairs using a 3% inflation rate) are listed in the table below:

Estimated Repair Costs (per housing unit)

| <u>Base</u> | <u>Cost of Repairs per Recommendations</u> | | <u>Cost of Planned Repairs</u> | |
|-------------|--|-------------|--------------------------------|-------------|
| Mayport | 2000: \$15K | 2025: \$31K | 2010: \$13K | 2035: \$30K |
| NAS Jax | 2000: \$5K | 2025: \$31K | 2000: \$0K | 2025: \$21K |
| Kings Bay | 2000: \$15K | 2025: \$31K | 2010: \$13K | 2035: \$30K |

The next important consideration was to project the likelihood of the various categories of hurricanes hitting the Jacksonville area in the next 50 years. Using a table from an article entitled "Engineering the Building Envelope - To Do or Not to Do" from Hurricanes of 1992, that predicted the probability and of the various categories of hurricanes hitting the Miami area in the next 50 years, these values were modified for the Jacksonville area by reducing the probability to 1/3 of the Miami value. The probabilities used in this study were as follows:

Hurricane Probability

| <u>Category</u> | <u>Wind Speed (mph)</u> | <u>Probability of One Hurricane in 50-Year Period</u> |
|-----------------|-------------------------|---|
| I | 74-95 | 2/3 |
| II | 96-110 | 1/3 |
| III | 111-130 | 1/10 |
| IV | 131-150 | 1/30 |
| V | >150 | 1/120 |

Each category of hurricane is likely to hit the Jacksonville area no more than one time in the fifty year period. Years for each of the five hurricane categories were selected randomly as follows: Category I - 1930, II - 1942, III - 1907, IV - 1948, and V - 1921.

The estimated cost of damages as a result of each category of hurricane at each base is the final crucial data element in this assessment. Rough estimates were made for the average damage per housing unit expected for each class of hurricane at each base at the present value, depending on whether the recommended changes were made or not.

With recommended improvements, potential costs that were considered included roof and interior repair for Category I and II storms, massive renovation and temporary resident displacement costs for Category III and IV storms, and total replacement and

resident displacement costs for Category V storms. Total replacement was based upon a cost of \$75,000 for one unit of housing in the year 2000. Temporary displacement costs were based upon \$200 per day for each housing unit. The estimated potential damage costs with implemented corrective actions at present values (year 2000) are listed below:

Recommended Actions Taken -

Present Value Damage Estimate (2000)/Future Value Damage Estimate

| <u>Category</u> | <u>Year/Multiplier</u> | <u>Mayport</u> | <u>NAS Jax</u> | <u>Kings Bay</u> |
|-----------------|------------------------|-----------------|----------------|------------------|
| I | 2030/1.8603 | \$5K/\$12.1K | \$5K/\$12.1K | \$5K/\$12.1K |
| II | 2042/3.4607 | \$10K/\$34.6K | \$5K/\$17.3K | \$10K/\$34.6K |
| III | 2007/1.2299 | \$50K/\$61.5K | \$25K/\$30.7K | \$45K/\$55.3K |
| IV | 2048/4.1323 | \$85K/\$351.2K | \$45K/\$186.0K | \$80K/\$330.6K |
| V | 2021/1.8603 | \$110K/\$204.6K | \$85K/\$158.1K | \$110K/\$204.6K |

If no changes are made, considerations would be similar to those for the different categories of storms. Nearly the same level of damage would be expected in Category IV and V storms, but they would likely be significantly higher for the smaller storms. The estimated repair costs per unit if no corrective actions are taken are as follows:

Recommended Actions Not Taken -

Present Value Damage Estimate (2000)/Future Value Damage Estimate

| <u>Category</u> | <u>Year/Multiplier</u> | <u>Mayport</u> | <u>NAS Jax</u> | <u>Kings Bay</u> |
|-----------------|------------------------|-----------------|----------------|------------------|
| I | 2030/1.8603 | \$30K/\$72.8K | \$15K/\$36.4K | \$25K/\$60.7K |
| II | 2042/3.4607 | \$50K/\$173.0K | \$25K/\$86.5K | \$45K/\$155.7K |
| III | 2007/1.2299 | \$85K/\$104.5K | \$45K/\$55.3K | \$80K/\$98.4K |
| IV | 2048/4.1323 | \$85K/\$351.2K | \$85K/\$351.2K | \$80K/\$330.6K |
| V | 2021/1.8603 | \$110K/\$204.6K | \$85K/\$158.1K | \$110K/\$204.6K |

The charts on the following six pages are a graphical representation of the estimated life cycle costs in the tables on the previous page. Please note conditions concerning whether corrective actions are implemented or not.

NAVAL STATION MAYPORT - CORRECTIVE ACTIONS TAKEN

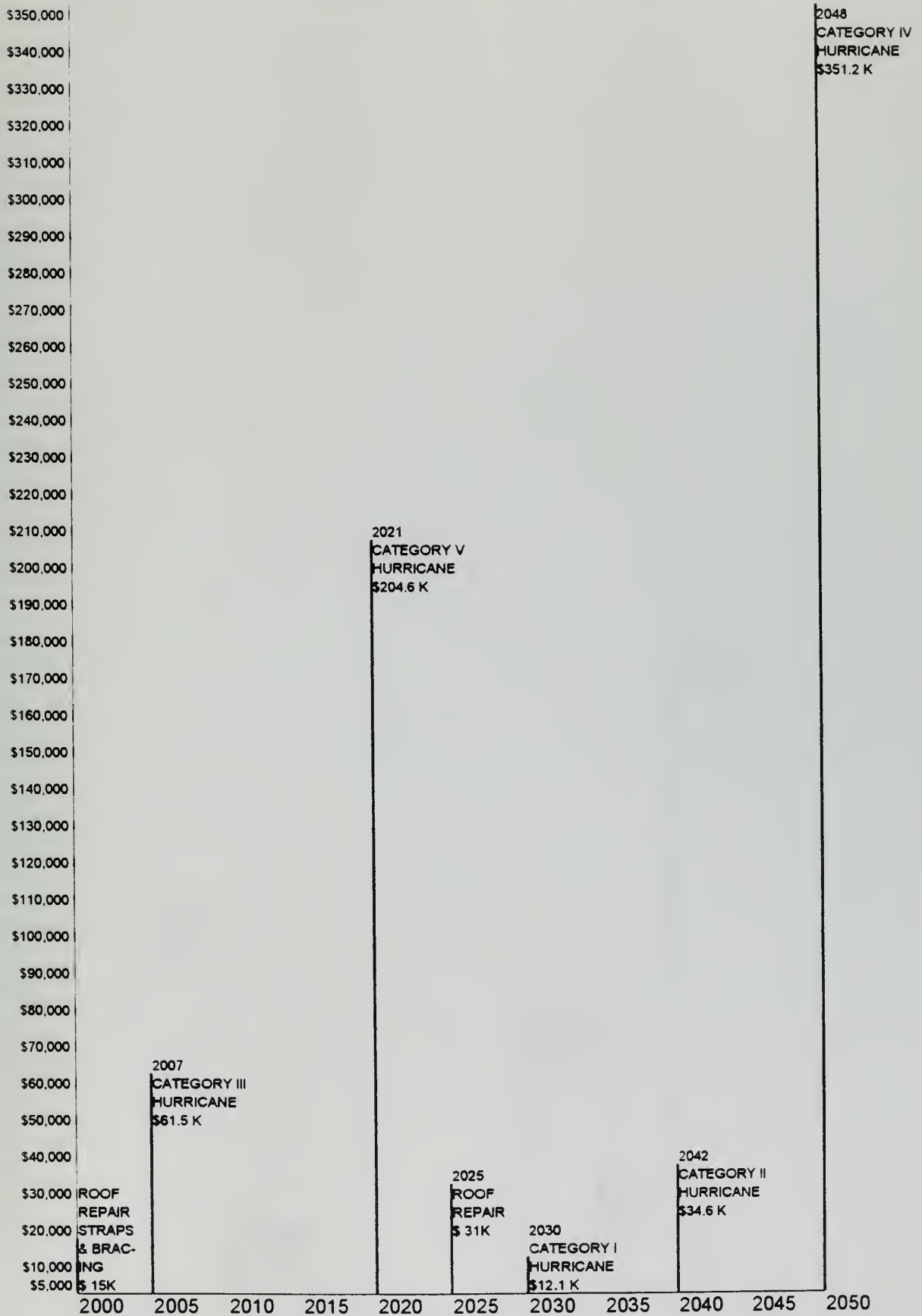

NAVAL STATION MAYPORT - CORRECTIVE ACTIONS NOT TAKEN

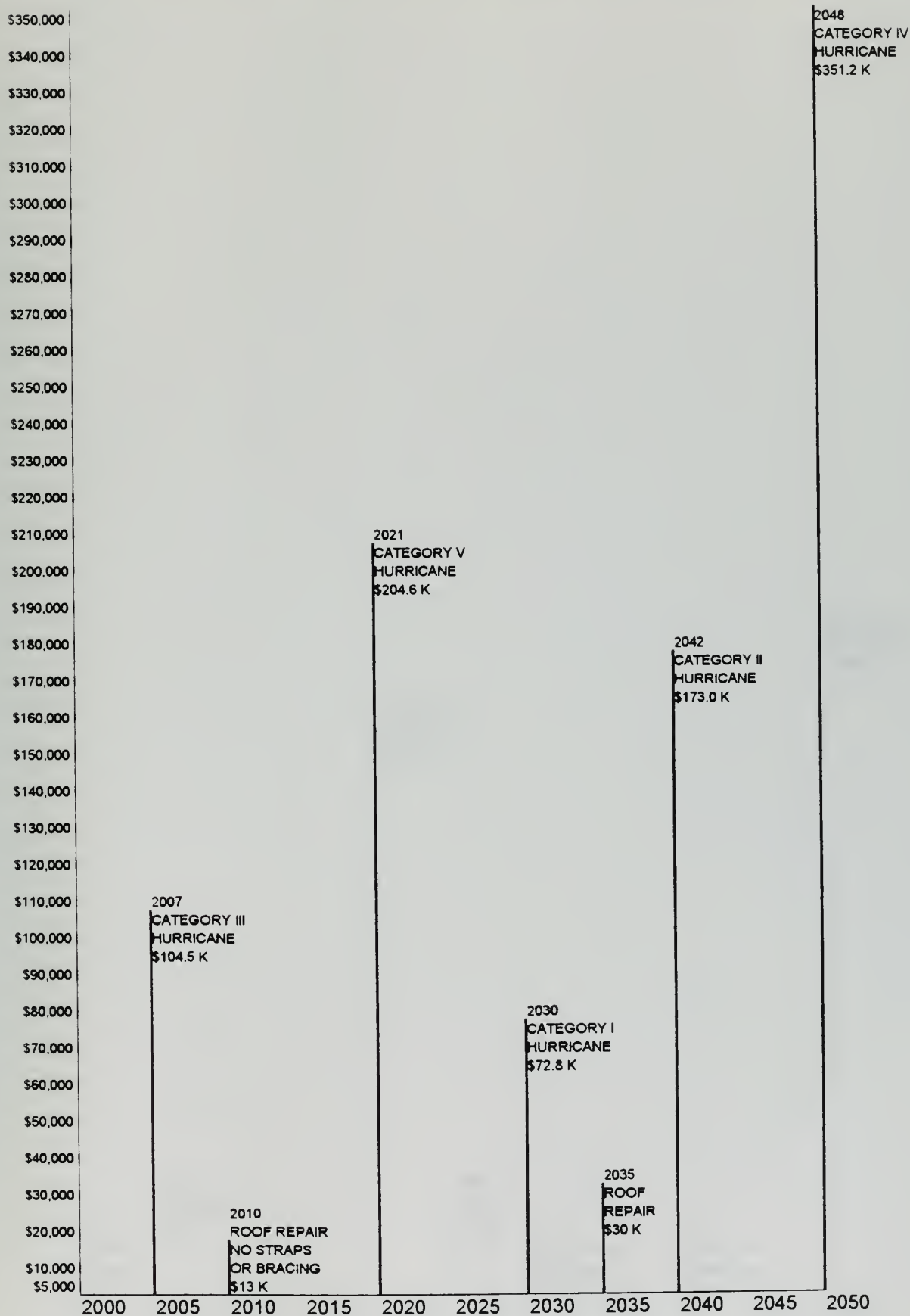

NAVAL AIR STATION JACKSONVILLE - CORRECTIVE ACTIONS TAKEN

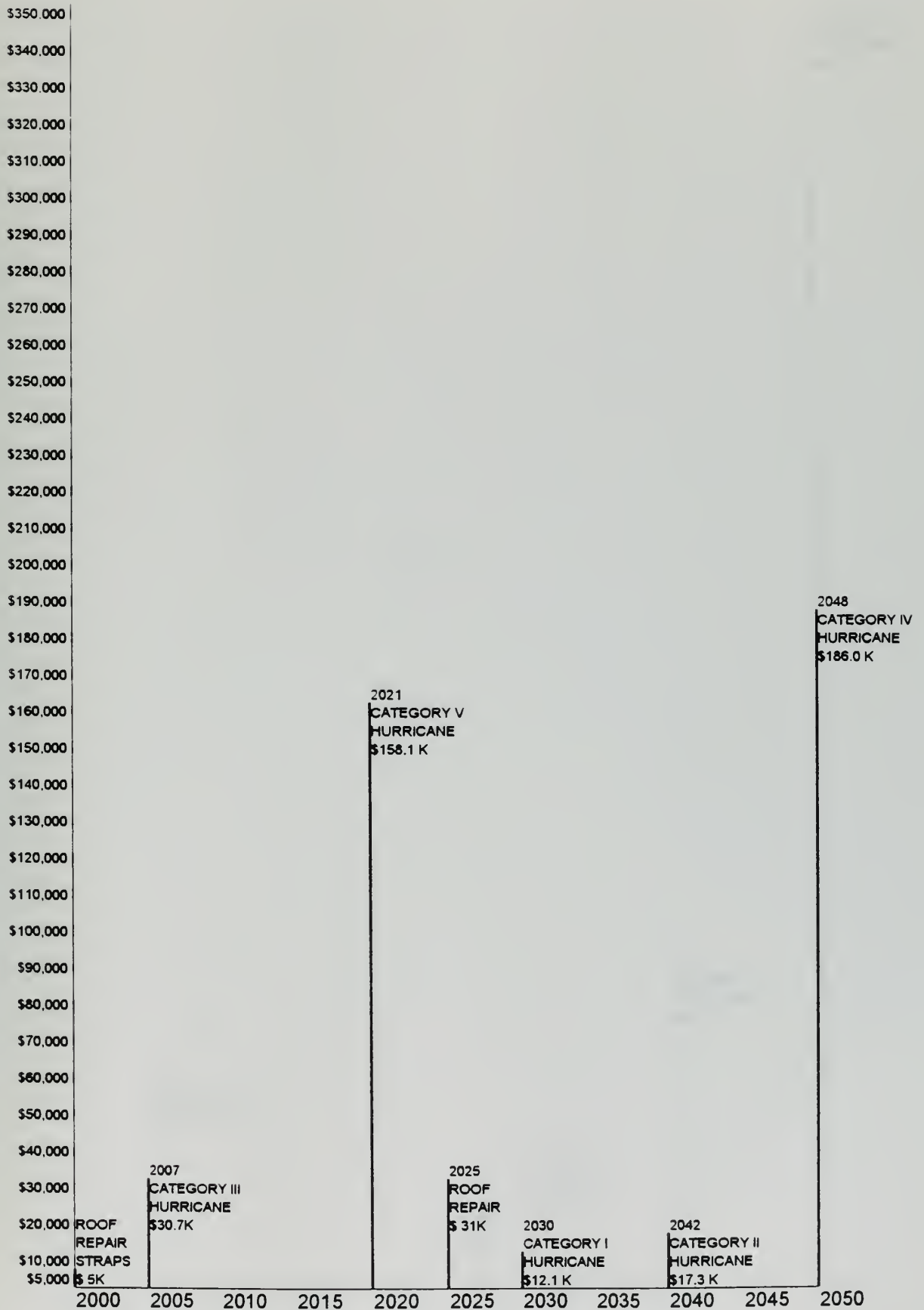

NAVAL AIR STATION JACKSONVILLE - CORRECTIVE ACTIONS NOT TAKEN

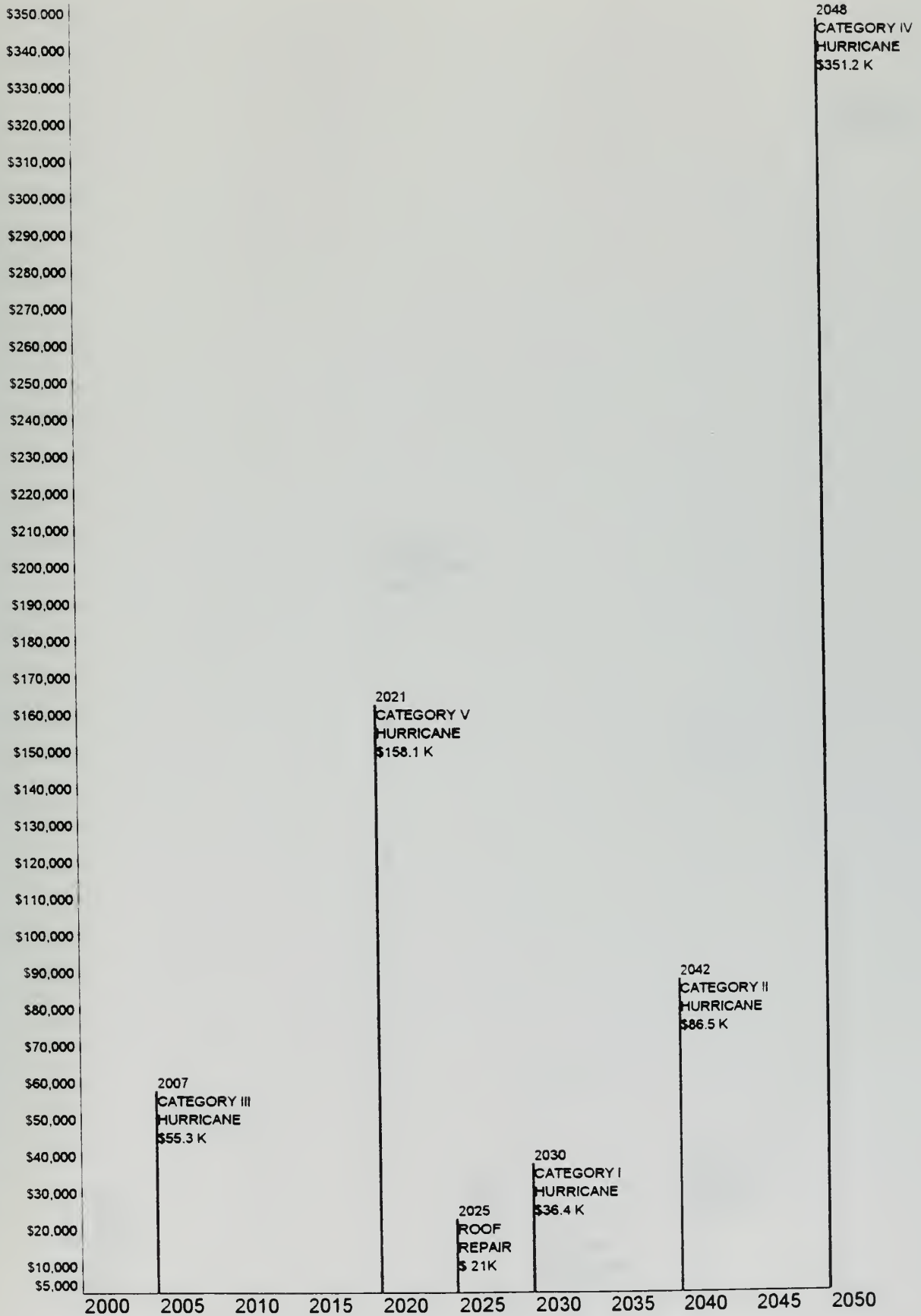

NAVAL SUB BASE KINGS BAY - CORRECTIVE ACTIONS TAKEN

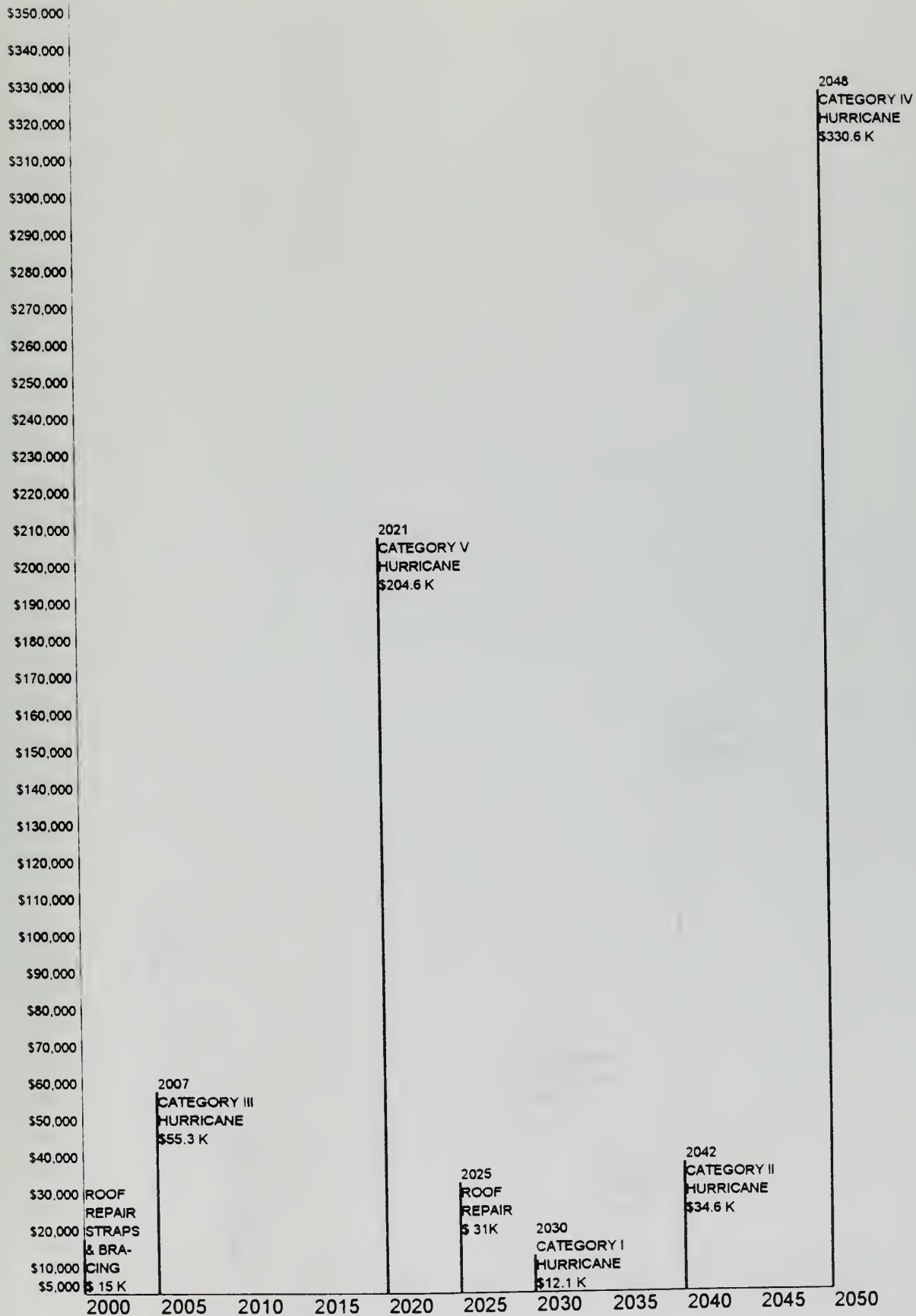

NAVAL SUB BASE KINGS BAY - CORRECTIVE ACTIONS NOT TAKEN

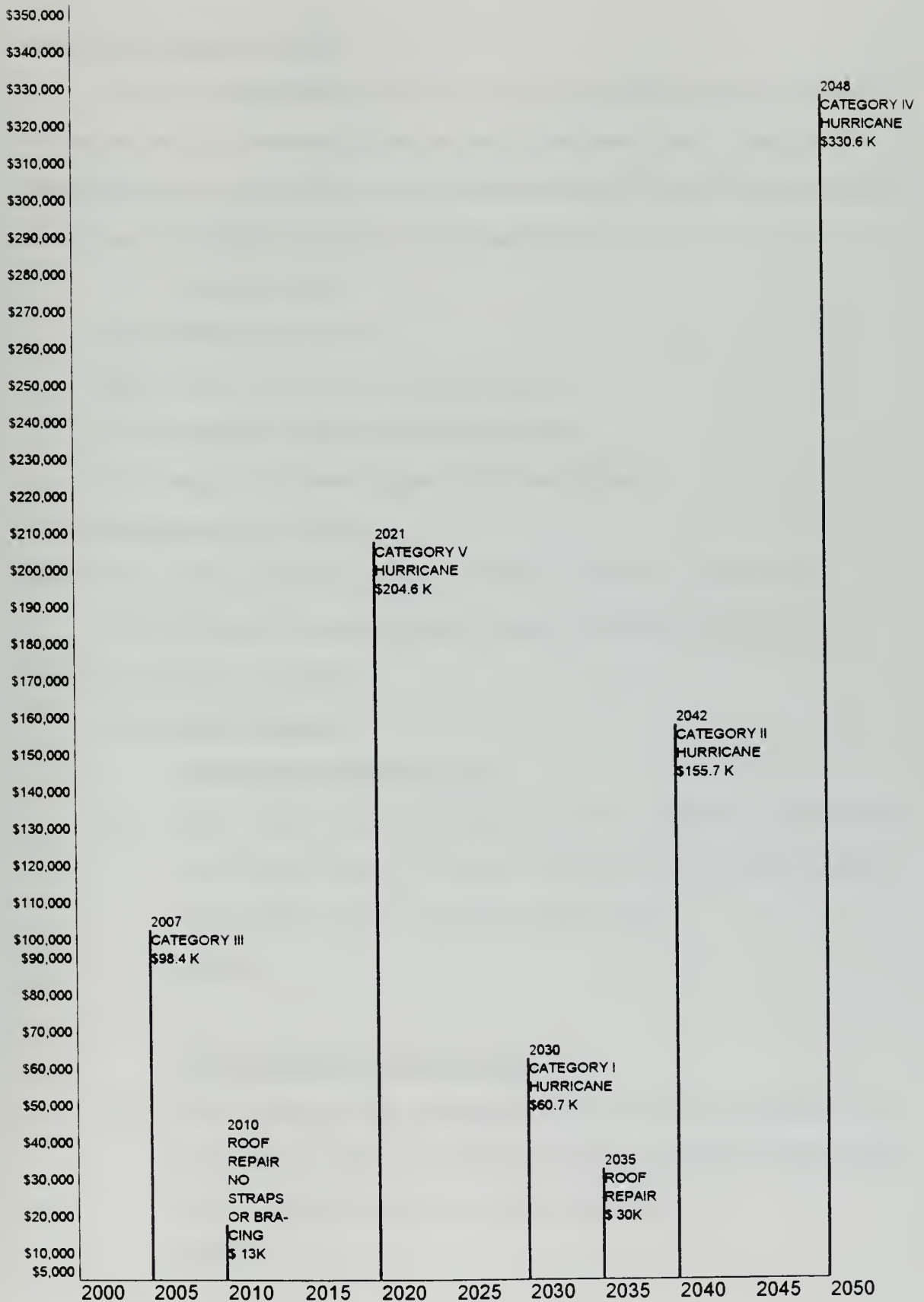

Net Present Value Calculations

In order to determine the net present value per unit for each of the two scenarios at the three bases, it is necessary to take the sum of the present value of repairs and the resulting products of the present values of estimated damages for each hurricane type and their respective probabilities. The following symbols apply:

NPV=Net Present Value

IRC = Initial Repair Costs

PRC = Periodic Repair Costs (at present value)

Pi = Probability of Category i Hurricane Striking

Di = Damage Costs from Category i Hurricane Striking

The resulting equation is as follows:

$$NPV = IRC + PRC + (P1 * D1) + (P2 * D2) + (P3 * D3) + (P4 * D4) + (P5 * D5)$$

The Net Present Value calculations for each of the three bases under the two different scenarios are as follows:

Naval Station Mayport

Recommended Actions Taken

$$\begin{aligned} NPV &= IRC + PRC + (P1 * D1) + (P2 * D2) + (P3 * D3) + (P4 * D4) + (P5 * D5) \\ &= 15K + 15K + (.67 * 5K) + (.33 * 10K) + (.1 * 50K) + (.033 * 85K) + (.0083 * 110K) \\ &= 15K + 15K + 3.3K + 3.3K + 5K + 2.8K + 0.9K \\ &= \$45.3K \end{aligned}$$

Recommended Actions Not Taken

$$\begin{aligned} NPV &= IRC + PRC + (P1 * D1) + (P2 * D2) + (P3 * D3) + (P4 * D4) + (P5 * D5) \\ &= 10K + 10K + (.67 * 30K) + (.33 * 50K) + (.1 * 85K) + (.033 * 85K) + (.0083 * 110K) \\ &= 10K + 10K + 20K + 16.5K + 8.5K + 2.8K + 0.9K \\ &= \$68.7K \end{aligned}$$

Naval Air Station Jacksonville

Recommended Actions Taken

$$\begin{aligned} \text{NPV} &= \text{IRC} + \text{PRC} + (\text{P1} * \text{D1}) + (\text{P2} * \text{D2}) + (\text{P3} * \text{D3}) + (\text{P4} * \text{D4}) + (\text{P5} * \text{D5}) \\ &= 5\text{K} + 15\text{K} + (.67 * 5\text{K}) + (.33 * 5\text{K}) + (.1 * 25\text{K}) + (.033 * 45\text{K}) + (.0083 * 85\text{K}) \\ &= 5\text{K} + 15\text{K} + 3.3\text{K} + 1.7\text{K} + 2.5\text{K} + 1.5\text{K} + 0.7\text{K} \\ &= \$29.7\text{K} \end{aligned}$$

Recommended Actions Not Taken

$$\begin{aligned} \text{NPV} &= \text{IRC} + \text{PRC} + (\text{P1} * \text{D1}) + (\text{P2} * \text{D2}) + (\text{P3} * \text{D3}) + (\text{P4} * \text{D4}) + (\text{P5} * \text{D5}) \\ &= 0\text{K} + 10\text{K} + (.67 * 15\text{K}) + (.33 * 25\text{K}) + (.1 * 45\text{K}) + (.033 * 85\text{K}) + (.0083 * 85\text{K}) \\ &= 0\text{K} + 10\text{K} + 10\text{K} + 8.3\text{K} + 4.5\text{K} + 2.8\text{K} + 0.7\text{K} \\ &= \$36.3\text{K} \end{aligned}$$

Naval Submarine Support Base Kings Bay

Recommended Actions Taken

$$\begin{aligned} \text{NPV} &= \text{IRC} + \text{PRC} + (\text{P1} * \text{D1}) + (\text{P2} * \text{D2}) + (\text{P3} * \text{D3}) + (\text{P4} * \text{D4}) + (\text{P5} * \text{D5}) \\ &= 15\text{K} + 15\text{K} + (.67 * 5\text{K}) + (.33 * 10\text{K}) + (.1 * 45\text{K}) + (.033 * 80\text{K}) + (.0083 * 110\text{K}) \\ &= 15\text{K} + 15\text{K} + 3.3\text{K} + 3.3\text{K} + 4.5\text{K} + 2.6\text{K} + 0.9\text{K} \\ &= \$44.6\text{K} \end{aligned}$$

Recommended Actions Not Taken

$$\begin{aligned} \text{NPV} &= \text{IRC} + \text{PRC} + (\text{P1} * \text{D1}) + (\text{P2} * \text{D2}) + (\text{P3} * \text{D3}) + (\text{P4} * \text{D4}) + (\text{P5} * \text{D5}) \\ &= 10\text{K} + 10\text{K} + (.67 * 25\text{K}) + (.33 * 45\text{K}) + (.1 * 80\text{K}) + (.033 * 80\text{K}) + (.0083 * 110\text{K}) \\ &= 10\text{K} + 10\text{K} + 16.7\text{K} + 15.0\text{K} + 8.0\text{K} + 2.6\text{K} + 0.9\text{K} \\ &= \$63.2\text{K} \end{aligned}$$

Cost Savings of Corrective Actions

Naval Station Mayport

For Mayport, the life cycle cost savings of the corrective actions is \$23,400 (\$68,700 - \$45,300) per unit at present value. The total savings based upon 681 housing units is \$15,935,400. The total increase in initial and periodic cost of repairs is \$6,810,000 ($\$10,000 * 681$). The present value cost benefit of the recommended corrective actions for Mayport is \$9,125,400.

Naval Air Station Jacksonville

For NAS Jax, the life cycle cost savings of the corrective actions is \$6,600 (\$36,300 - \$29,700) per unit at present value. The total savings based upon 318 housing units is \$2,098,800. The total increase in initial and periodic cost of repairs is \$3,180,000 ($\$10,000 * 318$). There is no cost benefit for the recommended corrective actions. The increase in expenditures is \$1,082,200.

Naval Submarine Support Base Kings Bay

For Kings Bay, the life cycle cost savings of the corrective actions is \$18,600 (\$63,200 - \$44,600) per unit at present value. The total savings based upon 665 housing units is \$12,369,000. The total increase in initial and periodic cost of repairs is \$6,650,000 ($\$10,000 * 665$). The present value cost benefit of the recommended corrective actions is \$5,719,000.

CHAPTER VIII RECOMMENDATIONS AND CONCLUSIONS

Overview

This study of recent hurricanes and their effects on housing structures as well as the cost analysis of the three Jacksonville area Navy bases provides a basis to draw conclusions and make recommendations for the bases studied as well as all Navy bases that could be impacted by hurricanes. Specific recommendations for the three bases are made, and more general recommendations for the present housing structures at other bases as well as potential new construction are also made.

Specific Recommendations for Studied Naval Installations

The life cycle cost analysis performed on the housing facilities at Mayport, NAS Jax, and Kings Bay yielded varying results. It is important to remember that the cost estimates for the proposed corrective actions in Chapter VII are only roughly accurate as are those estimates for potential recovery costs for different category of hurricanes. However, the estimates were consistent among the three bases. It is also important to note that the final cost savings of taking the proposed corrective actions as opposed to not taking them is largely based on the respective probabilities of the different categories of storms striking the Jacksonville area. Obviously, if a hurricane of great strength did indeed strike Jacksonville in the next fifty years, the corrective actions would provide tremendous savings.

Naval Station Mayport

For Mayport, the total present value cost benefit in making the proposed corrective actions is \$9,125,400. Given this significant savings and the location of the

housing area right on the beach, Mayport should strongly consider pursuing the revisions much sooner than the roof renovations likely to be performed around 2010. The proposed corrective actions are reprinted below:

1. Install hurricane straps and diagonal bracing as soon as possible. These actions would probably reduce the damage caused by a major hurricane by at least one half. It is likely that a Category III storm or higher would essentially destroy the current roof systems of nearly every housing unit on the base.
2. Install additional masonry units at the endwalls to the roofline. This could be done easily at the time of the next roof renovations.
3. Ensure minimum nailing requirements for roof sheathing, in accordance with SSTD 10-93, are met at the time of the next roof renovations, and ensure composition shingles rated for high wind areas are installed.
4. Install anchor positions to facilitate the rapid installation of plywood coverings on window openings. Purchase plywood and anchoring devices, store them at the individual units, and train the residents in the proper installation at annual hurricane preparedness briefs. Provide public works assistance in the installation process during evacuation preparations.
5. Install bracing on the garage doors in the single units. Also, perform a study on the condition of the door tracks and perform the necessary strengthening measures.
6. Monitor the sand dunes and consider raising the height of the dunes to provide greater storm surge protection.

Considering a large percentage of the cost of these actions is associated with the first two items, action could be taken on items 3-6 quickly, inexpensively, and mostly using in-house resources.

Naval Air Station Jacksonville

According to the analysis in Chapter 6, there is no cost benefit to implementing the recommended corrective actions. Based upon the probability of hurricanes striking Jacksonville, the increase in expenditures is predicted to be just more than \$1 million at present value. However, if additional funds of approximately \$1.5 million are available for the soon approaching renovations, the housing structures would be much better prepared for hurricanes, particularly those of Category III strength or less. The recommended corrective actions for NAS Jax are reprinted below:

1. Install hurricane straps. The existing structures could probably withstand a Category I and possibly a Category II storm. Depending upon the weakening effect of landfall, a greater storm would likely destroy the renovated roof systems as they are currently designed.
2. Install additional masonry units at the endwalls to the roofline.
3. Ensure minimum nailing requirements for roof sheathing in accordance with SSTD 10-93 are met at the time of the upcoming roof renovations, and ensure composition shingles rated for high wind areas are installed. Modify the contract if the current specifications do not conform to the Code.
4. Install anchor positions to facilitate the rapid installation of plywood coverings on the large window openings. Purchase plywood and anchoring devices, store them at the individual units, and train the residents in the proper installation at annual hurricane preparedness briefs. Provide public works assistance in installation process during evacuation preparations. This is of low priority, but the small cost of this suggestion would likely save damage to the interior of the homes.
5. Perform periodic surveys to check the condition of large trees near homes. Cut down trees showing signs of age that pose the threat of falling on housing units.

If funding is available, consideration of a modification to the upcoming contract should be taken in order to implement the first three items above. The final two recommended corrective actions could and should be performed quickly at minimal cost using in-house resources.

Naval Submarine Support Base Kings Bay, Georgia

According to the life cycle cost analysis performed in Chapter VII, Kings Bay would benefit greatly from the recommended corrective actions. The present value savings for the housing facilities at Kings Bay if the corrective actions are implemented in 2000 is \$5,719,000. Based upon this savings as well as the housing area's close proximity to the shore, the corrective actions reprinted below should be included at the time of the next roof renovation, and strong consideration of performing those renovations sooner than planned should be taken. The recommended corrective actions are as follows:

1. Install hurricane straps and diagonal bracing when the roof systems are renovated and as soon as possible. The present roof structures could probably withstand a Category I and, to some degree, a Category II storm. Depending upon the weakening effect of landfall, a greater storm would very likely destroy the entire roof systems.
2. Study the feasibility of installing exterior wall studs which extend from the second floor to the roof line.
3. Ensure minimum nailing requirements for roof sheathing in accordance with SSTD 10-93 are met at the time of roof renovations, and ensure composition shingles rated for high wind areas are installed.
4. Investigate the feasibility of moving the downspouts so that they would not interfere with shutters that could be installed to provide window protection. Also, install anchor positions to facilitate the rapid installation of plywood coverings on the sliding glass doors. Purchase plywood and anchoring devices, store them at the individual units, and

train the residents in the proper installation at annual hurricane preparedness briefs.

Provide public works assistance in the installation process during evacuation preparations

5. Perform periodic surveys to check the condition of tall trees near homes. Cut down trees showing signs of age that pose the threat of falling on housing units.

6. Perform a survey of playground equipment in the housing areas and determine if anchoring is secure to withstand at least Category II winds.

As with the base at Mayport, the first three recommendations comprise the large majority of the cost increase. Therefore, whether or not the first three items are taken for action, the final three could and should be implemented as soon as possible using in-house resources when possible.

General Recommendations for Navy Housing Construction and Renovations

There are several aspects in which the Navy could better ensure a higher level of hurricane preparedness of family housing. Improved practices in both design and construction could improve the overall preparedness immeasurably. Most of the following recommendations would be easy to implement in a short period of time, and several require very little funding. Instead, paying more attention to certain aspects of design, construction, as well as planning and maintenance, would go far in reducing the amount of damage incurred during a major hurricane.

Design

1. Conform to SSTD-10-93 in renovations. The lack of hurricane straps between walls, floors, and roof systems is the greatest deficiency. In addition, diagonal bracing of the top truss chord near gable endwalls is not evident, and the gable exterior masonry or studs stop at the ceiling line instead of extending to the roof. These items should be corrected

whenever roof renovations are performed on Navy housing in coastal areas. The Navy is not exempt from the Code, and ignorance of the Code appears to be widespread.

2. Design housing with more aerodynamic shapes. In particular, hip roof systems are highly recommended over those with gable endwalls.
3. Composition shingles manufactured and rated as satisfactory for high wind areas should be an essential design component in coastal areas.
4. Include venting with adequate openings to relieve internal pressures on roof systems.
5. Two-car garage doors should be avoided. Wide spans without girts and mullions generally perform poorly during high winds. In housing renovation designs, consideration should be given to stabilizing two-car garage doors with girts and mullions.
6. Window design should allow for protection of windows from shutters or precut plywood.
7. Exterior doors should be designed to withstand the appropriate wind loads.
8. Strong consideration of using masonry construction over wood-frame in potential high wind areas should be taken. On the whole, masonry structures have performed better than wood-frame buildings against both heavy winds and storm surge during hurricanes.
9. Modular buildings should be considered a good alternative, but careful attention must be paid to strengthening the endwalls.
10. Accessory structures such as porch framing, lightpoles, and playground equipment should be designed to withstand winds greater than the 75 mph currently required. These items pose a great danger as flying debris.

Construction

1. Improve the quality of construction through strong inspection practices. With the increasing Navy practice of utilizing the Contractor Quality Control (CQC) program, this task is less controllable. CQC representatives' experience records should be thoroughly

checked, and there should be some provision for familiarity with current codes such as SBCCI's SSTD 10-93 for Hurricane Resistant Residential Construction. Better familiarity with the code by Resident Officer in Charge of Construction (ROICC) representatives, particularly with respect to design reviews, would also greatly assist this effort.

2. ROICC representatives should conduct inspections of roof bracing and sheathing prior to the installation of roof underlayment. Installation of hurricane straps and minimum nailing requirements for sheathing and shingles should receive particular attention.
3. For tile roof coverings, ROICC representatives should ensure that traffic is not allowed on the roof for at least 72 hours after installation, and no work should be done on any part of the structure for 24 hours to allow the tile to properly set without vibration of the roof framing or sheathing.

Planning and Maintenance

1. Survey the housing vicinity for trees and other objects that are particularly susceptible to high winds and which pose a threat to the neighboring homes. Take the appropriate action to eliminate those threats.
2. Consider installing anchoring devices at window openings for precut plywood protection. Stage the plywood at the individual homes, and instruct the residents on installation of the plywood in annual hurricane preparedness briefings.

Conclusions

Navy housing facilities in coastal areas are fairly well prepared for hurricanes, but steps could be easily taken at minimal cost to ensure an even better posture against the threats posed by these storms. Overall, the housing studied at the three bases would probably perform well in a Category I hurricane and possibly a Category II storm, but hurricanes of greater damage would likely cause significant damage.

Military housing facilities are very basic and generally provide essential dwelling needs. They are initially built at low costs, and they are expected to last a long time despite the questionable quality of design and construction, as well as the number of families which move in and out of a particular unit over many years, none of whom regard the house as a permanent home. In most cases, the existing housing was built to meet minimum standards. With regard to hurricane preparedness, those standards have changed in recent years, and the Navy is required to conform to the changing Code requirements at the time of renovations. Ignorance to the Code requirements and limited funding are the likely explanations for overlooking items such as hurricane straps and diagonal bracing during renovations. A strong effort must be made to obtain the necessary funds to meet the requirements that could save a tremendous amount of money in the long run.

Taking the actions recommended in this chapter would result in much better overall hurricane preparedness of Navy housing facilities. These recommendations will not prevent all damages during a Category V hurricane, but they could go a long way in drastically reducing the repair costs and resident displacement time after a Category III or IV storm. In addition to saving money, this would reduce the family concerns and enable the base personnel to concentrate on their work-related tasks in an effort to get base fully operational again.

The recommended actions should be implemented as soon as reasonably possible, and the idea of accelerating planned renovations, particularly roofs, should be seriously considered. All of the actions would ultimately serve a great purpose in better protecting our Navy bases and the people who live and work there.

BIBLIOGRAPHY

U. S. Army Corps of Engineers, Report on Hurricane Camille, 14-22 August 1969, U. S. Army Corps of Engineers, New Orleans, 1970.

National Research Council, Hurricane Hugo: Puerto Rico, The U. S. Virgin Islands, and South Carolina, September 17-22, 1989, National Academy of Sciences, Washington, 1994.

Rappaport, Ed, Preliminary Report: Hurricane Andrew, 16-28 August 1992, U.S. Government Printing Office, Washington, 1993.

Cook, Ronald A., "Overview of Hurricane Andrew in South Florida," Hurricanes of 1992, American Society of Civil Engineers, New York, 1994, p. 70.

Stubbs, Norris and Dale C. Perry, "Engineering of the Building Envelope "To Do or Not To Do"" Hurricanes of 1992, American Society of Civil Engineers, New York, 1994, p. 10.

Federal Emergency Management Agency, Federal Insurance Agency, Building Performance: Hurricane Andrew in Florida, U.S. Government Printing Office, Washington, 1992.

Mayfield, Max, Preliminary Report: Hurricane Opal, 27 September - 6 October 1995, National Hurricane Center, 1995.

Nichols, Gary G., Sam Gerace, and James C. Slaght, A Survey of Hurricane Opal, Southern Building Code Congress International, Birmingham, 1996.

Standard for Hurricane Resistant Residential Construction SSTD 10-93, Southern Building Code Congress International, Birmingham, 1993.



DUDLEY KNOX LIBRARY



3 2768 00354529 4